



麗勳企業有限公司
LI-HSUN INDUSTRIAL CO., LTD.

40850 台中市南屯區工業22路33號
No.33, 22nd Road, Industrial Park, Taichung City 40850, Taiwan.
TEL : 886-4-23507788 FAX : 886-4-23502120
E-mail : lihsun66@ms38.hinet.net website : www.lihsun.com



公司簡介

www.lihsun.com
C O M P A N Y P R O F I L E



麗勳企業有限公司於西元1978年成立，一直秉持著【求質、求實、求、求新】的理念提供顧客最好的產品與服務。更研發製造一系列CNC超高速迴轉頂針、替換式頂針、高性能頂針及重型迴轉頂針...等產品約10多種高速、輕、中、重型之迴轉頂針。此外更進一步研發出Z軸設定器（光電型、附錶型）、尋邊器（光電式、機械式）以及不導磁之全陶瓷尋邊器、搪孔器系列。

在累積了三十幾年的技術、經驗及全體員工不斷的努力下，更積極研發設計一系列產品，為進入國際市場奠定更穩固的基礎。面對新世紀的挑戰，積極強化企業體系以增加產品競爭力；不斷提供顧客優越的產品及服務，努力朝向“發展創新、提昇效率、保證質量”，之目標向前邁進。本公司更朝鑽頭、銑刀研磨機系列研發、設計...

LI-HSUN INDUSTRIAL CO., LTD. was founded in 1978 and moved into the Taichung Industrial Park in October 2003 with 1,682 meters of factory and company premise. We always adhere to the operational principle of "Looking for high quality, utility and innovation" to provide our customers with the best product service.

Under our constant research and development, we provide a series of CNC superior and high performance centers, interchangeable insert centers, high performance centers, and heavy-duty rotary centers, etc. More than ten kinds of rotary centers include high speed, light, medium-duty, and heavy-duty types. Furthermore, we have developed the Z Axial Preset (optical and dial gauge type), Edge Finder (optical and mechanical type), and non-conduction fully ceramic edge finder.

After more than three decades of rich experience having been accumulated, the specialized operations conducted with the improving technologies, along with the strong dedication and continuous effort from our staff to develop and design a series of newly innovative products, have altogether laid the solid foundation for Li Hsun to enter the global market. To face up to the challenges of the new century, Li Hsun progressively consolidates the symmetrical structure of its enterprise in order to increase the competitiveness of the products. At all times, Li Hsun aims to provide the users with superior products and outstanding service. Striving to continue our innovative product development with guaranteed quality is our ultimate and highest regard. Li Hsun currently devotes its R&D energy into fast drill and end mill re-sharpening machines.



麗勳企業公司為提高產品之精度使其產品更為優良，購入高端瑞士研磨機 (STUDER)，使產品達到精益求精，同時帶來更多使用麗勳企業有限公司產品之客戶，擁有更好的加工產能以及精準度。

LIHSUN INDUSTRIAL CO., LTD. imported CNC universal cylindrical grinding machine(STUDER) form Swiss to improve products' concentricity deviation accuracy that aim to be the excelsior on this field. To satisfy our customers with the best processing capacity and accuracy.



公司簡介 COMPANY PROFILE Page 1-2

固定頂針 SOLID CENTERS Page 5-7

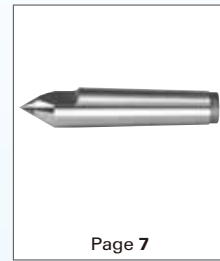

尋邊器/ Z軸設定器 EDGE FINDER & Z AXIAL PRESET GAUGE Page 30-35

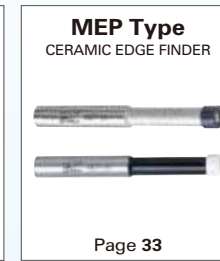
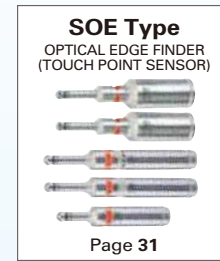

傳統車床 CONVENTIONAL LATHE Page 8-12

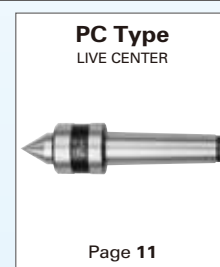
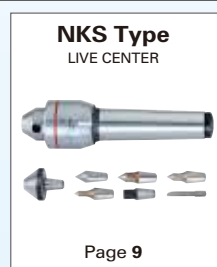

拉桿螺栓 PULL STUDS Page 36-38

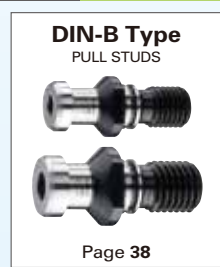
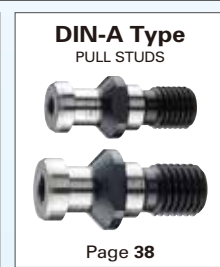

鑽夾頭 DRILL CHUCKS Page 39-42

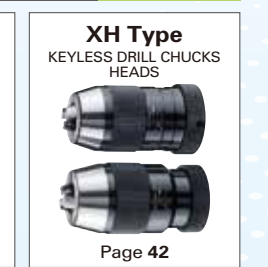

電腦數值控制車床(CNC) COMPUTERIZED NUMERICAL CONTROL LATHE Page 14-24

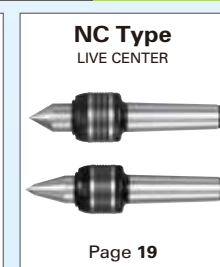
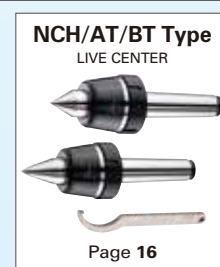
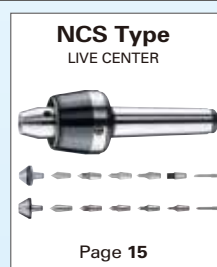

研磨機 RE-SHARPENING Page 44-52

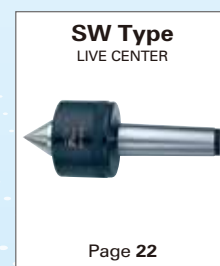
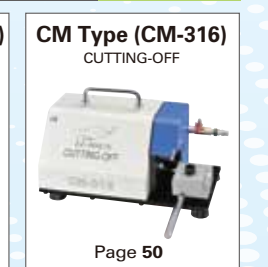
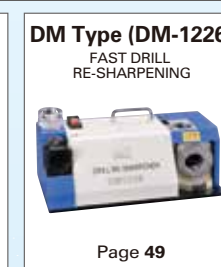

零配件 PARTS & ACCESSORIES Page 25-27

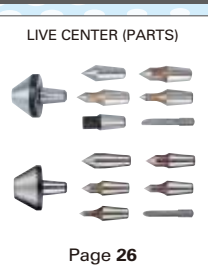

客製化頂針 CUSTOMIZED CENTERS Page 28-29

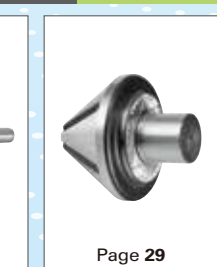
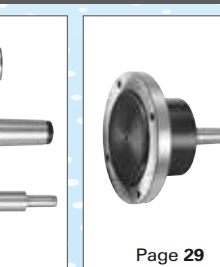
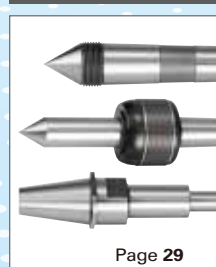

螺旋角修磨機 ENDMILL HELIX RE-SHARPENING Page 54-56



CE 證書/各國專利 PATENT CERTIFICATE Page 57-58

固定頂針 SOLID CENTERS

www.lihsun.com

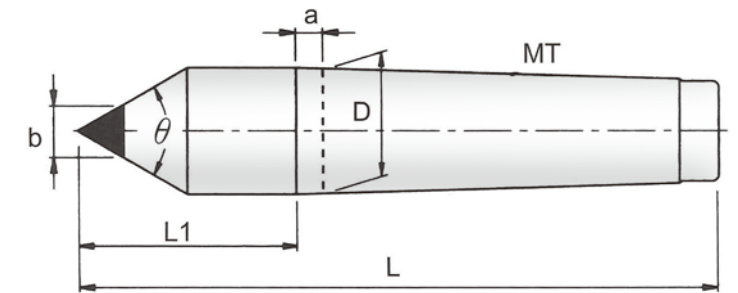

1. 本體使用高碳鋼之材質；經熱處理。
2. 本體及頂心經過精密研磨處理。
3. 適用於車床及磨床等機械。
4. 外徑斜度(Morse Taper)採用DIN806規格。

1. Body is made of carbon tool steel with heat treatment.
2. Body and Center is under precise grinding process.
3. Application to lathe and grinder.
4. Morse Taper complies with DIN806 standard.

單位/Unit:mm

產品規格 MODEL No.	D	a	b	L1	L	Co.精度 Accuracy	θ
MT3C10	23.825	5	10	39	125	0.005	60°
MT4C14	31.267	6.5	14	46	155	0.005	60°
MT5C18	44.399	6.5	18	64	200	0.005	60°
MT6C30 (訂製品)	63.348	8	30	80	270	0.005	60°

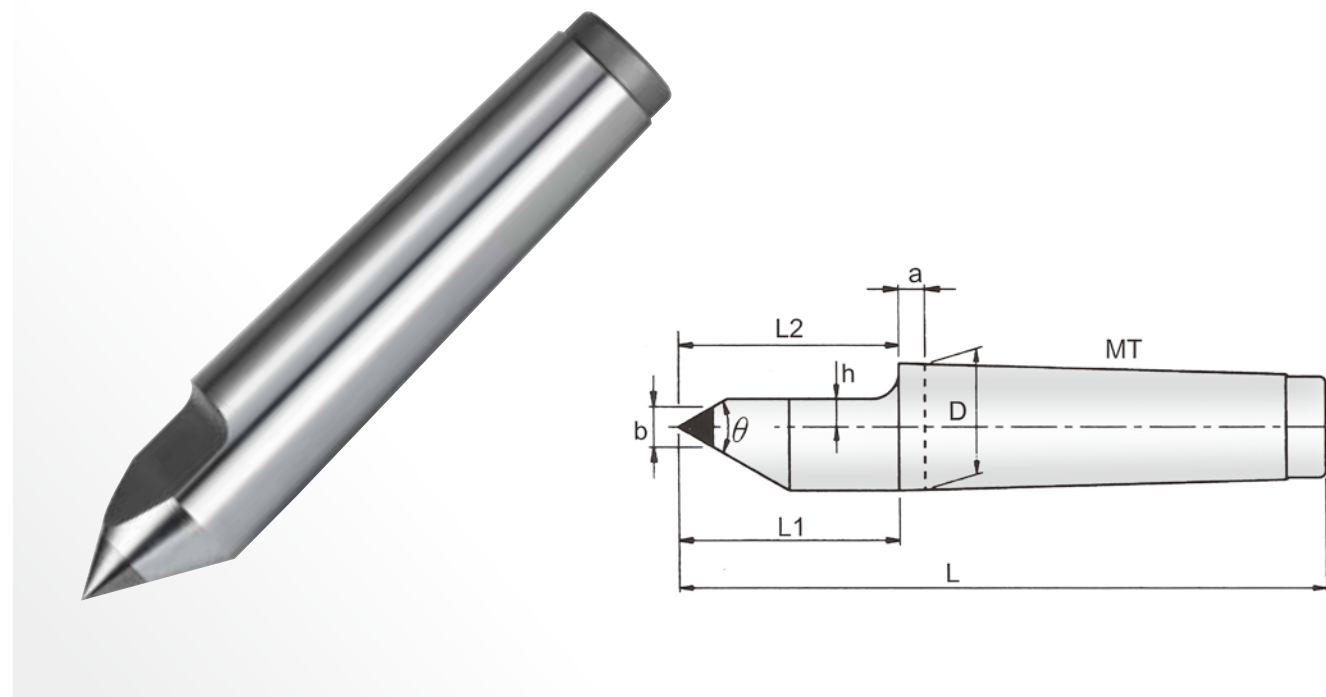

1. 本體使用高碳鋼之材質；經熱處理。
2. 本體及頂心經過精密研磨處理。
3. 適用於車床及磨床等機械。
4. 外徑斜度(Morse Taper)採用DIN806規格。

1. Body is made of carbon tool steel with heat treatment.
2. Body and Center is under precise grinding process.
3. Application to lathe and grinder.
4. Morse Taper complies with DIN806 standard.

單位/Unit:mm

產品規格 MODEL No.	D	a	b	h	L1=L2	L	Co.精度 Accuracy	θ
MT3C10	23.825	5	10	6	39	125	0.005	60°
MT4C14	31.267	6.5	14	8	46	155	0.005	60°
MT5C14	44.399	6.5	14	8	64	200	0.005	60°

傳統車床 CONVENTIONAL LATHE

www.lihsun.com



迴轉頂針

ROLLING TYPE

RPM: 2000 - 5000 MT/MK. 2, 3, 4, 5

NK 型 LIVE CENTER

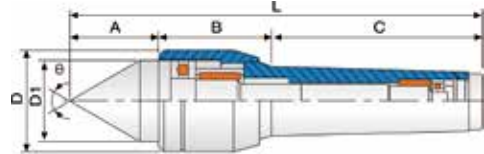
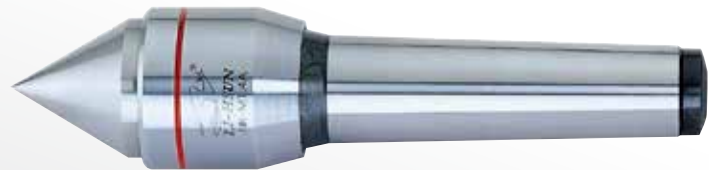

A-TYPE

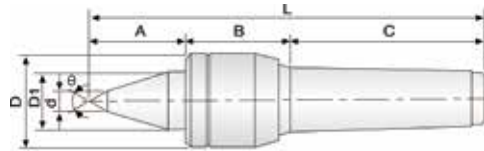
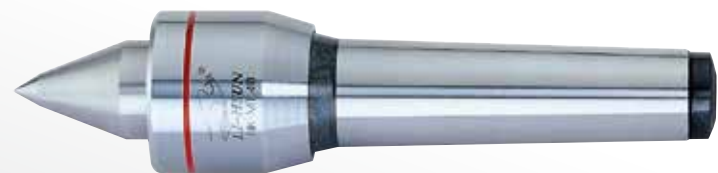

B-TYPE

特殊規格 SPECIAL ORDER

鎢鋼 WITH CARBIDE TIPPED

AW-TYPE BW-TYPE

NKS 型 LIVE CENTER

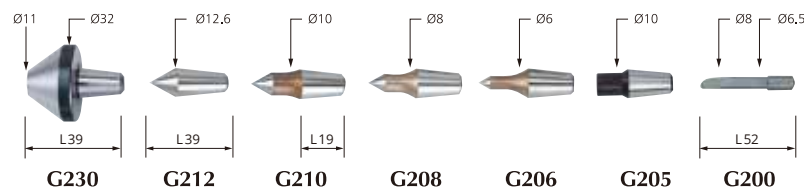
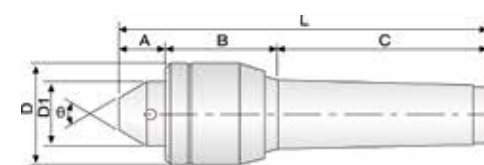

NK 型 LIVE CENTER

1. 心軸及本體使用軸承鋼之材質，經適當熱處理為(HRC60° ± 1°)
 2. 此頂針使用止推軸承，針狀軸承及滾針軸承，滾珠軸承之組合。
 3. 適用中、高速之車床，及中負載使用。
 4. 車床尾座調整壓力建議 5~8 公斤。
- ※ NK-B型;適合中小工作物之加工切削。

1. Center shaft and main body are made of dearing alloy steel and hardened to (HRC60° ± 1°).
 2. Center is assembled with thrust bearing, needle bearing and ball bearing.
 3. Applicable to medium and high speed lathes with heavy loads.
 4. The tailstock pressure of lathe adjusts to five to eight kilograms (for reference)
- ※ NK-B model: Long nose live centers are suitable for small workpieces.

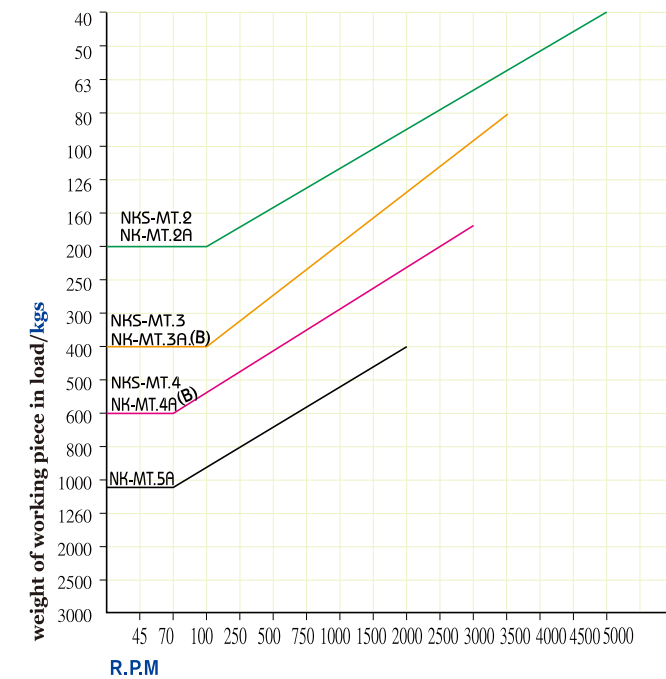

單位/Unit:mm

ORDER NO.	MORES TAPER MT/MK	A	B	C	D	D1	d	L	d1	Co精度 Accuracy	Max R.P.M	θ	G.W. weight kgs	包裝尺寸 L x W x H
08040002	NK-MT.2A	28	35	69	32	23	-	132	-	0.003	5000R.P.M	60°	0.38 kgs	175 x 45 x 45
08040003	NK-MT.3A	36	44	86	41	35	-	166	12	0.003	3500R.P.M	60°	0.88 kgs	200 x 65 x 53
08040004	NK-MT.4A	41	51	108	47	40	-	200	12	0.003	3000R.P.M	60°	1.48 kgs	240 x 80 x 65
08040005	NK-MT.5A	54	72	136	65	52	-	262	18	0.003	2000R.P.M	60°	3.60 kgs	300 x 90 x 90
08040013	NK-MT.3B	46	44	86	41	25	10	176	12	0.003	3500R.P.M	60°	0.84 kgs	200 x 65 x 53
08040014	NK-MT.4B	55	51	108	47	32	12	214	12	0.003	3000R.P.M	60°	1.44 kgs	240 x 80 x 65
08040022	NKS-MT.2	22	36	69	32	25	-	127	-	0.005	5000R.P.M	60°	0.84 kgs	173 x 102 x 62
08040023	NKS-MT.3	23	44	86	41	30	-	153	-	0.005	3500R.P.M	60°	1.16 kgs	235 x 130 x 100
08040024	NKS-MT.4	23	51	108	47	32	-	182	-	0.005	3000R.P.M	60°	1.60 kgs	235 x 130 x 100

普通型頂針

NORMAL TYPE

RPM: 2000 - 4500 MT/MK. 1, 2, 3, 4, 5



PC

型 LIVE CENTER

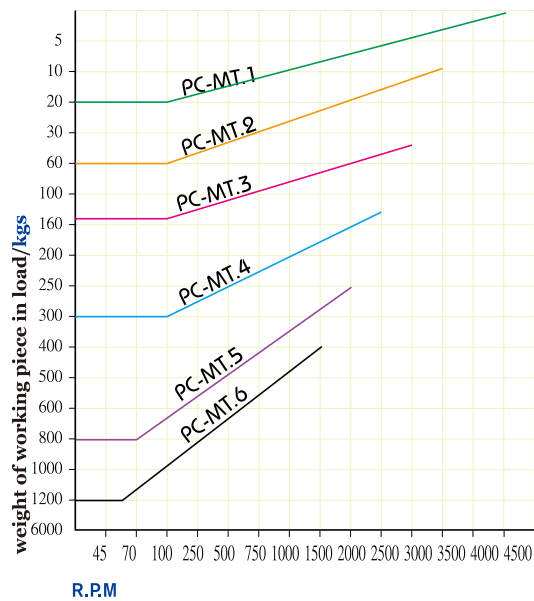
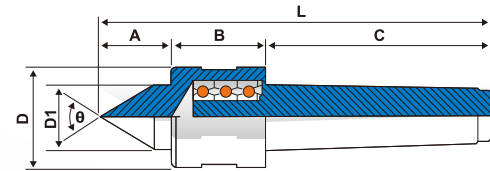

1. 此頂針使用鉻鉬鋼之材質，經適當熱處理為 (HRC58° ~ 60°) 具高鋼性。
 2. 此頂針為滾珠軸承之組合。
 3. 適用於中、高速車床及輕負載之使用。
 4. 車床尾座調整壓力建議 5~8 公斤。
1. Center is made of Cr-Mo steel and hardened to HRC 58° ~ 60°.
 2. Center is assembled with ball bearings.
 3. Applicable to medium and high speed lathes with light duty.
 4. The tailstock pressure of lathe adjusts to five to eight kilograms (for reference)

單位/Unit:mm

ORDER NO.	MORES TAPER MT/MK	A	B	C	D	D1	L	Co精度 Accuracy	Max R.P.M	θ	G.W. weight kgs	包裝尺寸 L x W x H
08080001	PC-MT.1	21	31	56	32	16	108	0.005	4500R.P.M	60°	0.22 kgs	110 x 40 x 40
08080002	PC-MT.2	26	37	69	40	22	132	0.005	3500R.P.M	60°	0.42 kgs	140 x 50 x 50
08080003	PC-MT.3	32	46	86	45	26	164	0.005	3000R.P.M	60°	0.82 kgs	170 x 50 x 50
08080004	PC-MT.4	34	46	108	48	30	188	0.005	2500R.P.M	60°	1.30 kgs	205 x 60 x 60
08080005	PC-MT.5	50	62	136	68	45	248	0.005	2000R.P.M	60°	2.44 kgs	260 x 80 x 80
08080006	PC-MT.6	65	82	190	102	55	337	0.008	1500R.P.M	60°	9.95 kgs	370 x 140 x 130

免夾頂針

WORK-DRIVING CENTER



DK

型 WORK-DRIVING CENTER - FIXED TIP

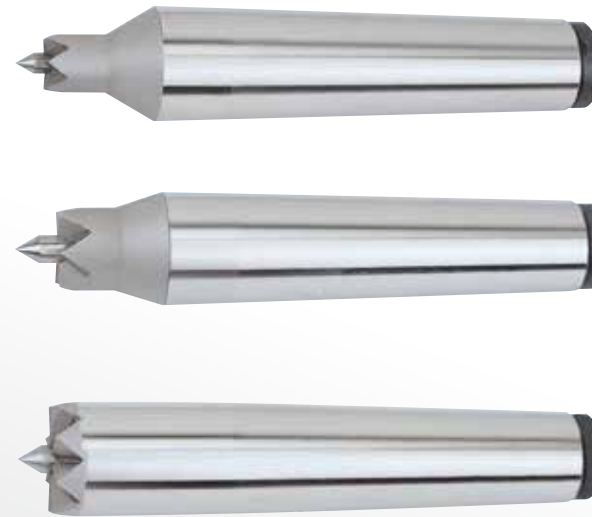

1. 此免夾頂針因機械之結構，故障率低。經深冷熱處理為(HRC60° ± 1°)。
 2. 以往車床加工使用傳動夾來帶動，避免工作物之停止，此免夾頂針在本體端面有6T及8T之設計來頂住加工之端面，就可免用傳動夾，使加工方便速度更快。
 3. 此免夾頂針，滾齒機械可適用。
 4. 精度：0.008mm
1. Body and center shaft are made of alloy steel with heat and sub-zero treatment.
 - ※ Hardened: HRC60° ± 1°.
 2. Driving dog is required for traditional lathes turning to prevent workpiece from stopping. These work driving centers are either with 6 teeth or 8 teeth design for superseding the driving dogs. It supports the workpiece on end surface for easy setup and rapid machining.
 3. The work-driving center is also applicable for gear hobbing machine.
 4. Accuracy: 0.008mm

DKS

型 WORK-DRIVING CENTER - CHANGEABLE TIPS

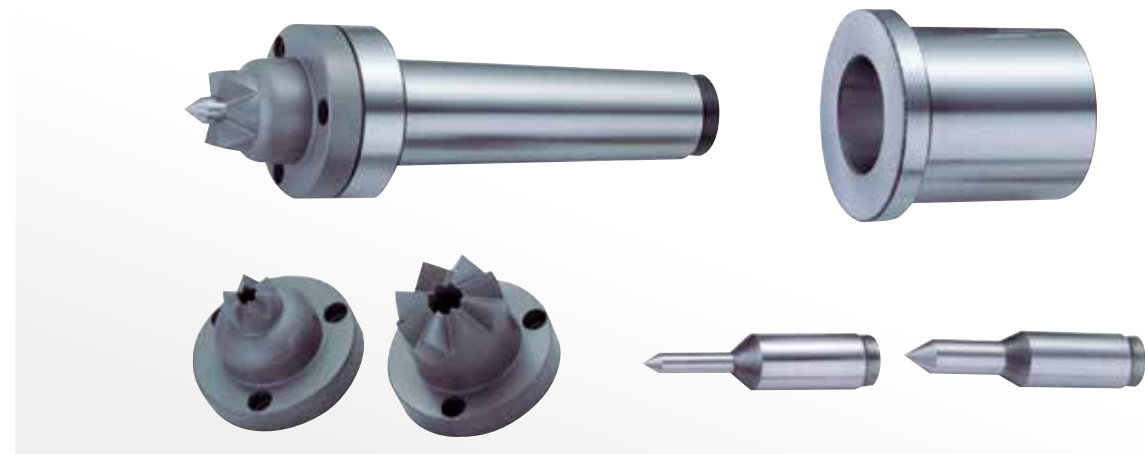

單位/Unit:mm

ORDER NO.	MORES TAPER MT/MK	心軸尺寸 Center Shaft size	外徑尺寸 Outer dia	工作範圍 Working range	G.W. WEIGHT kgs	包裝尺寸 L x W x H
08090015	DK-15 MT.4	6Ø	16Ø	16Ø - 25Ø	0.62 kgs	175 x 40 x 40
08090023	DK-23 MT.4	8Ø	23Ø	23Ø - 32Ø	0.64 kgs	175 x 40 x 40
08090032	DK-32 MT.4	8Ø . 14Ø	32Ø	32Ø - 45Ø	0.68 kgs	175 x 40 x 40
080900301	DKS-301 MT.4	6Ø . 8Ø . 10Ø	16Ø . 23Ø . 30Ø	15Ø - 45Ø	2.60 kgs	265 x 140 x 110

高速頂針

HIGH-SPEED, WATER-PROOF TYPE

RPM: 1500 - 5000 MT/MK. 3, 4, 5, 6



NCH 型 LIVE CENTER

迷宮式迴轉頂針無油封防水結構
專利號碼 M553237

MAZE TYPE, WATERPROOF DESIGNED
WITHOUT SEAL, PAT. NO. M553237

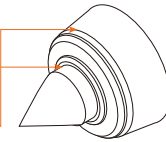

A-TYPE

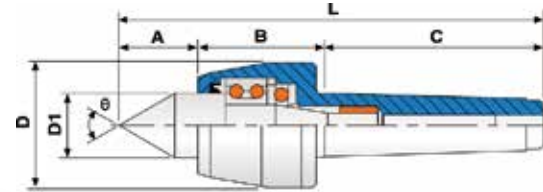

B-TYPE

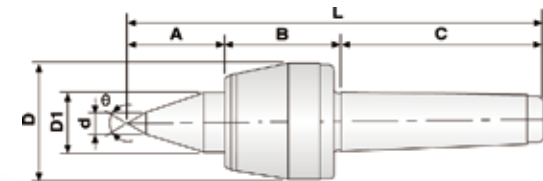

特殊規格 SPECIAL ORDER

鎢鋼 WITH CARBIDE TIPPED

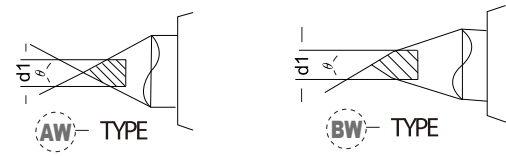

NCS 型 LIVE CENTER



NCS-MT.4P 和 NCS-MT.5P

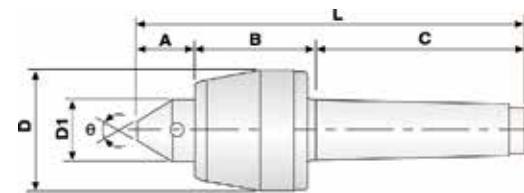

NCS-MT3 MT.4

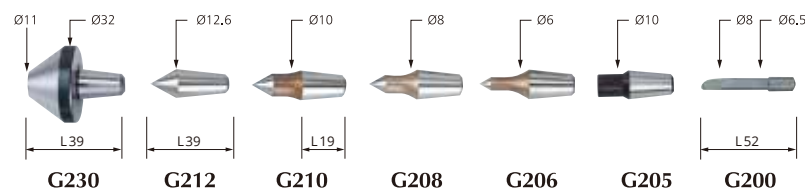

NCS-MT4P MT.5P

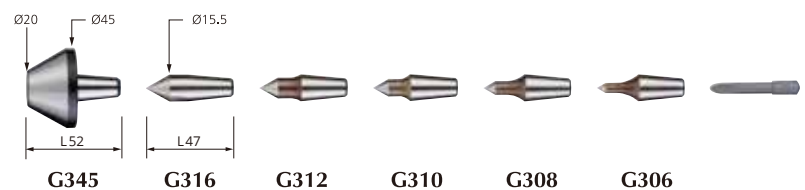

高速頂針 (附螺帽型)

HIGH-SPEED, WATER-PROOF TYPE



NCH 型 LIVE CENTER

迷宮式迴轉頂針無油封防水結構
專利號碼 M553237

MAZE TYPE, WATERPROOF DESIGNED
WITHOUT SEAL, PAT. NO. M553237

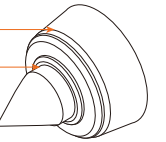

AT-TYPE



BT-TYPE

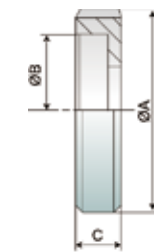
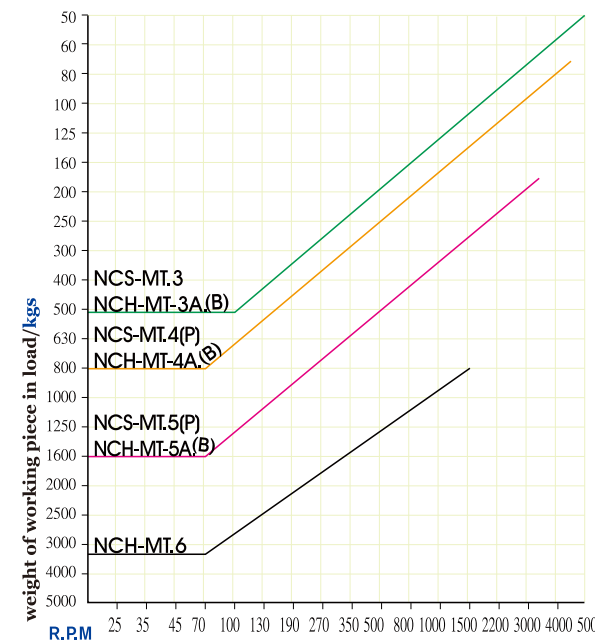

MORES TAPER MT / MK	DIMENSIONS (mm)		
	A	B	C
NCH-MT.4AT NCH-MT.4BT	69	M60 x 1.5	20
NCH-MT.5AT NCH-MT.5BT	92	M80 x 1.5	25

1. 前端使用雙列滾珠軸承及止推軸承，滾針軸承之組合。
 2. 此頂針適用於CNC車床，具中重負荷使用，具防水性。
 3. 車床尾座調整壓力建議5~8公斤。
- ※ NCH-B型:適合小工作物之加工切削。
1. Center shaft is made of alloy steel and hardened through vacuum heat treatment to provide higher rigidity HRC 60±1°.
 2. Center is fitted with dual ball bearing, thrust bearing and needle roller bearing assembly, the waterproof is maze type.
 3. The tailstock pressure of lathe adjusts to five to eight kilograms (for reference)
- ※ Applicable to high speed lathes and CNC lathes with heavy loads.

單位/Unit:mm

ORDER NO.	MORES TAPER MT/MK	A	B	C	D	D1	d	L	d1	Co精度 Accuracy	Max R.P.M	θ	G.W. WEIGHT kgs	包裝尺寸 L x W x H
08030003	NCH-MT.3A	39	55	86	53	30	-	180	12	0.003	5000R.P.M	60°	1.30 kgs	240 x 80 x 65
08030004	NCH-MT.4A	42	62	108	63	30	-	208	12	0.003	4500R.P.M	60°	2.08 kgs	263 x 100 x 90
08030005	NCH-MT.5A	49	71	136	83	40	-	256	18	0.003	3500R.P.M	60°	4.40 kgs	320 x 118 x 110
08030006	NCH-MT.6A	80	110	189	128	70	-	379	-	0.008	1500R.P.M	60°	16.5 kgs	425 x 185 x 180
08030013	NCH-MT.3B	45	55	86	53	30	10	186	12	0.003	5000R.P.M	60°	1.34 kgs	240 x 80 x 65
08030014	NCH-MT.4B	52	62	108	63	30	12	218	12	0.003	4500R.P.M	60°	2.12 kgs	263 x 100 x 90
08030015	NCH-MT.5B	59	71	136	83	40	14	266	18	0.003	3500R.P.M	60°	4.42 kgs	320 x 118 x 110
08030023	NCS-MT.3	28	55	86	53	30	-	169	-	0.005	5000R.P.M	60°	1.50 kgs	235 x 130 x 100
08030024	NCS-MT.4	30	62	108	63	30	-	196	-	0.005	4500R.P.M	60°	2.16 kgs	235 x 130 x 100
08030034	NCS-MT.4P	30	62	108	63	30	-	196	-	0.005	4500R.P.M	60°	2.70 kgs	238 x 132 x 80
08020035	NCS-MT.5P	34	71	136	83	40	-	237	-	0.005	3500R.P.M	60°	5.00 kgs	280 x 150 x 106
08020044	NCH-MT.4AT	42	62	108	60	30	-	208	12	0.003	4500R.P.M	60°	2.42 kgs	263 x 100 x 90
08020045	NCH-MT.5AT	49	71	136	80	40	-	256	18	0.003	3500R.P.M	60°	5.02 kgs	320 x 118 x 110
08020054	NCH-MT.4BT	52	62	108	60	30	12	218	12	0.003	4500R.P.M	60°	2.46 kgs	263 x 100 x 90
08020055	NCH-MT.5BT	59	71	136	80	40	14	266	18	0.003	3500R.P.M	60°	5.04 kgs	320 x 118 x 110

重負荷頂針

HEAVY-LOAD TYPE

RPM: 4000 - 6000 MT/MK. 3, 4, 5

NCF

型 LIVE CENTER

迷宮式迴轉頂針無油防水結構
專利號碼 M553237

MAZE TYPE, WATERPROOF DESIGNED
WITHOUT SEAL, PAT. NO. M553237

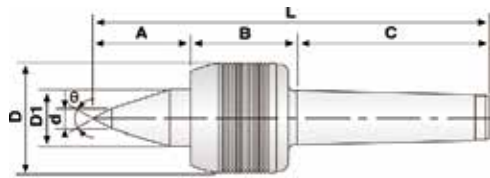
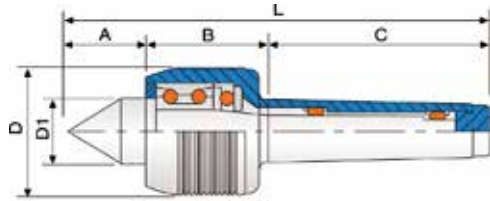
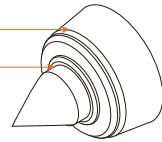

特殊規格 SPECIAL ORDER

鎢鋼 WITH CARBIDE TIPPED

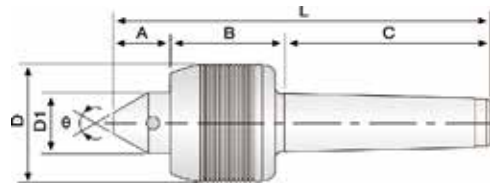
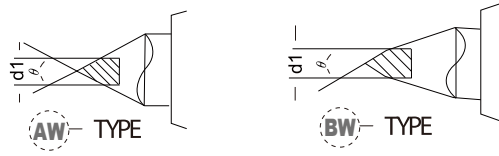

NCFP

型 LIVE CENTER

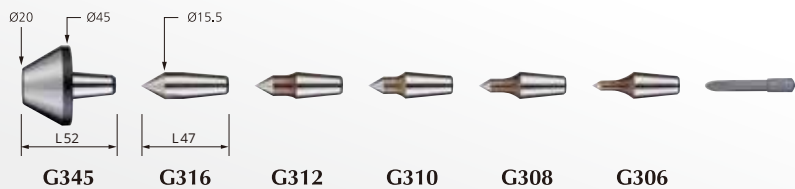

NCF

型 LIVE CENTER

- 心軸使用合金工具鋼之材質，經真空熱處理為(HRC60° ± 1°)具高鋼性及耐磨性。
- 前端使用雙列斜角滾珠軸承及止推軸承中段及後段使用滾針軸承之組合，具防水性。
- 車床尾座調整壓力建議 5~8 公斤。

※ NCF-B型；適合小工作物加工使用。

- The shaft is made of alloy steel and through vacuum heat treatment (HRC 60 ± 1°). It possesses great rigidity and high durability.
- Front end is fitted with angular contact ball bearing & thrust bearing. Middle & Rear end are fitted with needle bearing, the waterproof is maze type.
- The tailstock pressure of lathe adjusts to five to eight kilograms. (for reference)

※ NCF-B type: Long nose live centers are suitable for small workpieces.

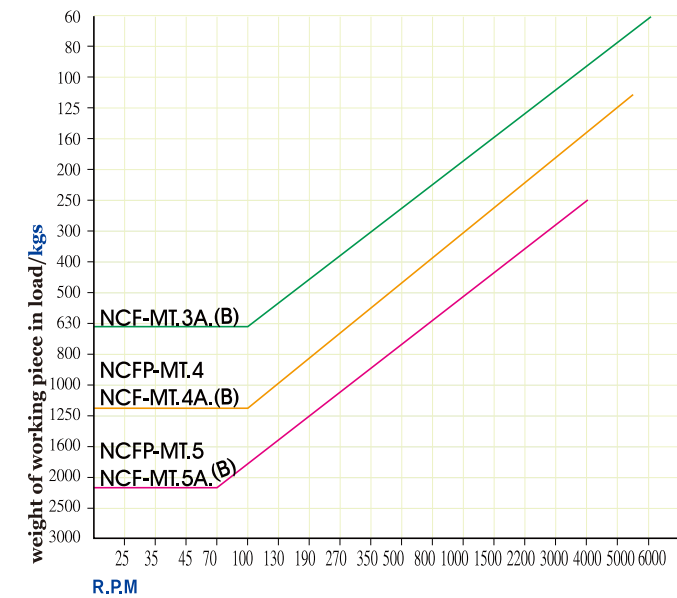

單位/Unit:mm

ORDER NO.	MORES TAPER MT/MK	A	B	C	D	D1	d	L	d1	Co精度 Accuracy	Max R.P.M	θ	G.W. WEIGHT kgs	包裝尺寸 L x W x H
08020003	NCF-MT.3A	38	50	86	53	30	-	174	12	0.003	6000R.P.M	60°	1.26 kgs	240 x 80 x 65
08020004	NCF-MT.4A	45	60	108	68	30	-	213	12	0.003	5500R.P.M	60°	2.36 kgs	263 x 100 x 90
08020005	NCF-MT.5A	52	70	136	87	40	-	258	18	0.003	4000R.P.M	60°	4.76 kgs	320 x 118 x 110
08020013	NCF-MT.3B	52	50	86	53	30	10	188	12	0.003	6000R.P.M	60°	1.32 kgs	240 x 80 x 65
08020014	NCF-MT.4B	55	60	108	68	30	12	223	12	0.003	5500R.P.M	60°	2.44 kgs	263 x 100 x 90
08020015	NCF-MT.5B	67	70	136	87	40	14	273	18	0.003	4000R.P.M	60°	4.84 kgs	320 x 118 x 110
08020024	NCFP-MT.4	29	64	108	68	30	-	201	-	0.005	5500R.P.M	60°	2.94 kgs	232 x 130 x 90
08020025	NCFP-MT.5	37	70	136	87	40	-	243	-	0.005	4000R.P.M	60°	5.40 kgs	280 x 150 x 100

中負荷頂針

MEDIUM-LOAD TYPE

RPM: 5000 - 6500 MT/MK. 4, 5



NC 型 LIVE CENTER

迷宮式迴轉頂針無油防水結構
專利號碼 M553237
MAZE TYPE, WATERPROOF DESIGNED
WITHOUT SEAL, PAT. NO. M553237

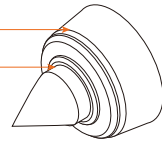

A-TYPE

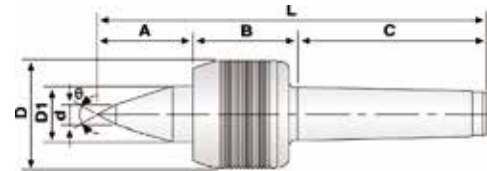

B-TYPE

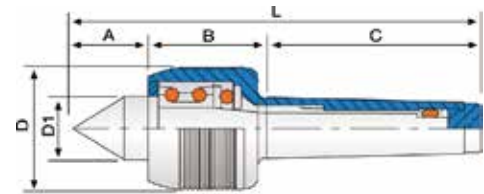

NCD 型 LIVE CENTER

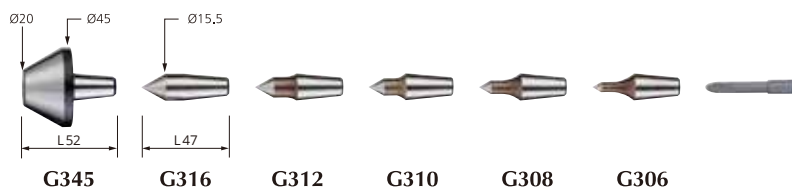
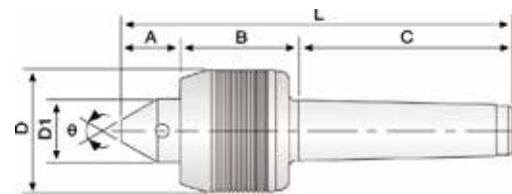

NC 型 LIVE CENTER

1. 前端使用雙列斜角滾珠軸承及止推軸承，及滾針軸承之組合。
 2. 此頂針適用於CNC車床，具高速及中負荷使用，具防水性。
 3. 車床尾座調整壓力建議5~8公斤。
- ※ NC-B型;適合小工作物之加工切削。

1. Front end is fitted with angular contact ball bearing, thrust bearing and needle bearing.
 2. These centers are suitable for CNC lathes at high-speed and medium-load. Waterproof design, the waterproof is maze type.
 3. The tailstock pressure of lathe adjusts to five to eight kilograms (for reference)
- ※ NC-B type: Long nose live centers are suitable for small workpieces.

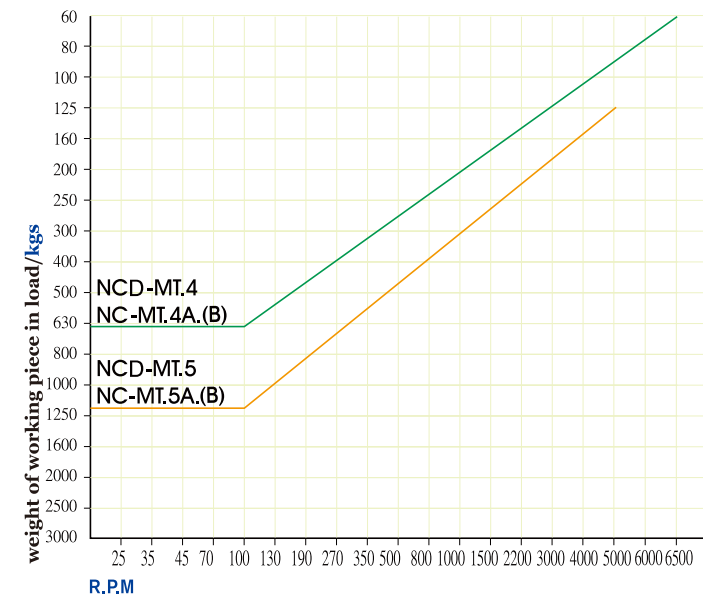

單位/Unit:mm

ORDER NO.	MORES TAPER MT/MK	A	B	C	D	D1	d	L	Co精度 Accuracy	Max R.P.M	θ	G.W. weight kgs	包裝尺寸 L x W x H
08200004	NC-MT.4A	44	55	108	53	30	-	207	0.003	6500R.P.M	60°	1.62 kgs	240 x 80 x 65
08200005	NC-MT.5A	48	61	136	68	35	-	245	0.003	5000R.P.M	60°	3.26 kgs	300 x 90 x 90
08200014	NC-MT.4B	52	55	108	53	30	12	215	0.003	6500R.P.M	60°	1.63 kgs	240 x 80 x 65
08200015	NC-MT.5B	58	61	136	68	35	14	255	0.003	5000R.P.M	60°	3.28 kgs	300 x 90 x 90
08200024	NCD-MT.4	33	55	108	53	30	-	196	0.005	6500R.P.M	30°	2.28 kgs	235 x 130 x 86
08200025	NCD-MT.5	37	61	136	68	35	-	234	0.005	5000R.P.M	30°	4.12 kgs	280 x 150 x 100

可調式頂針

ADJUSTMENT WATER-PROOF TYPE

RPM: 1500 - 5000 MT/MK. 3, 4, 5, 6



NCR

型 LIVE CENTER



A-TYPE



B-TYPE

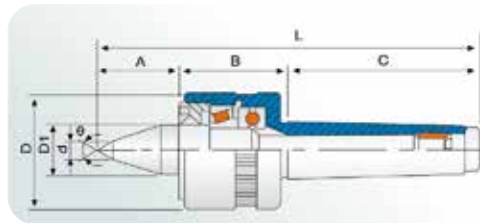
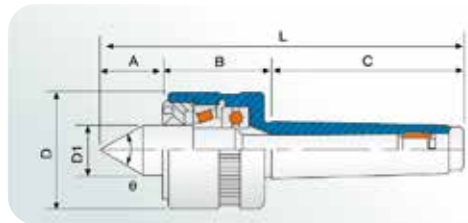

1. 心軸使用合金工具鋼之材質，經真空熱處理(HRC60° ± 1°) 具高鋼性及耐磨性。
2. 此頂針使用滾錐軸承，止推軸承及滾針軸承之組合。
3. 適用於中、重負荷使用，具防水性。
4. 車床尾座調整壓力建議5~8公斤。

※ 防水設計

1. The shaft uses alloy steel and hardened through vacuum heat treatment to (HRC60° ± 1°).
2. The center uses the combination of taper roller bearing, thrust bearing and needle bearing.
3. Applicable to medium and heavy loads, the waterproof is maze type.
4. The tailstock pressure of lathe adjusts to five to eight kilograms (for reference)
5. The center is adjustable to reach original loading capacity after using for a long period of time.

※ Long nose live centers are suitable for small workpieces.

※ Waterproof design.

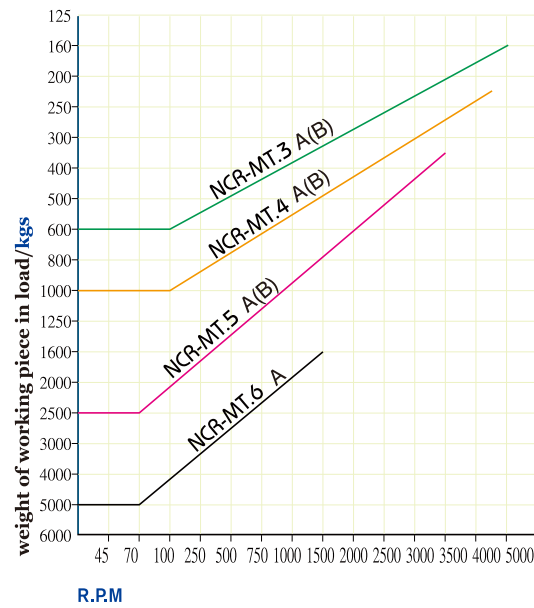

單位/Unit:mm

ORDER NO.	MORES TAPER MT/MK	A	B	C	D	D1	d	L	Co精度 Accuracy	Max R.P.M	θ	G.W. WEIGHT kgs	包裝尺寸 L x W x H
08070003	NCR-MT.3A	37	47	86	50	25	-	170	0.003	5000R.P.M	60°	1.12 kgs	240 x 80 x 65
08070004	NCR-MT.4A	45	59	108	65	32	-	212	0.003	4500R.P.M	60°	2.44 kgs	263 x 100 x 90
08070005	NCR-MT.5A	50	62	136	80	40	-	248	0.003	3500R.P.M	60°	4.32 kgs	320 x 118 x 110
08070006	NCR-MT.6A	66	85	189	128	60	-	333	0.008	1500R.P.M	60°	15.12 kgs	425 x 185 x 180
08070013	NCR-MT.3B	47	47	86	50	25	10	180	0.003	5000R.P.M	60°	1.13 kgs	240 x 80 x 65
08070014	NCR-MT.4B	55	59	108	65	32	12	222	0.003	4500R.P.M	60°	2.46 kgs	263 x 100 x 90
08070015	NCR-MT.5B	60	85	136	80	40	14	263	0.003	3500R.P.M	60°	4.52 kgs	320 x 118 x 110

超重負荷頂針

SUPER-LOAD TYPE

RPM: 1000 - 1800 MT/MK. 5, 6, 7, 80#



SW

型 LIVE CENTER

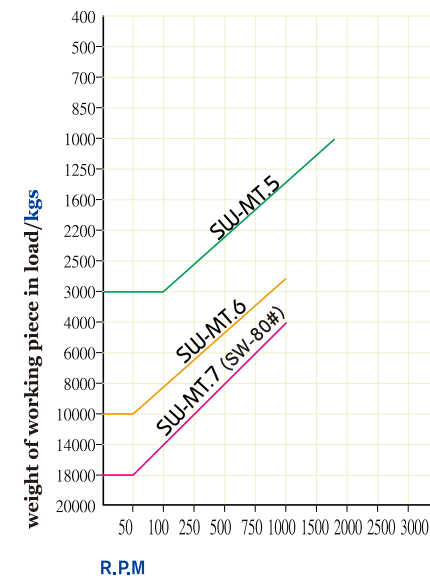
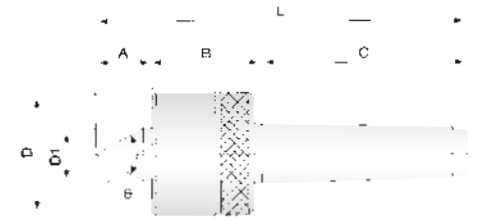

1. 心軸使用合金工具鋼之材質，經真空熱處理，使心軸更具耐磨性，硬度較高(HRC60° ~ 62°)。
2. 此頂針適用於重型車床及較重負荷載使用。
3. 車床尾座調整壓力建議5~12 公斤 (參考值)

※ 防水設計

1. Shaft uses alloy steel and hardened through vacuum heat treatment to (HRC 60° ~ 62°).
2. Applicable to heavy duty lathes.

3. The tailstock pressure of lathe adjusts to five to twelve kilograms. (for reference)

※ Waterproof design.

單位/Unit:mm

ORDER NO.	MORES TAPER MT/MK	A	B	C	D	D1	L	Co精度 Accuracy	Max R.P.M	θ	G.W. WEIGHT kgs	包裝尺寸 L x W x H
08060005	SW-MT.5	52	82	135	98	50	269	0.005	1800R.P.M	60°	6.8 kgs	340 x 140 x 125
08060006	SW-MT.6	74	116	190	148	70	380	0.008	1000R.P.M	60°	22 kgs	420 x 185 x 180
08060007	SW-MT.7	106	127	260	196	90	493	0.008	1000R.P.M	60°	42 kgs	530 x 242 x 235
08060008	SW- 80#	106	127	200	196	90	433	0.008	1000R.P.M	60°	40 kgs	530 x 242 x 235

傘型頂針

BULL NOSE CENTER TYPE



BC 型 LIVE CENTER

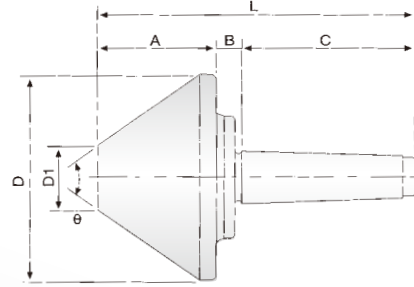

1. 傘型頂針頭部使用鉻鉬鋼材質，經熱處理 (HRC 60°±1°)。
2. 內部使用滾錐軸承滾珠軸承之組合。
3. 適用於較大內孔徑之加工使用。
4. 車床尾座調整壓力建議6~10公斤。

1. The tip of bull nose center uses Cr-Mo steel and hardened to (HRC 60°±1°).
2. The center uses a combination of taper roller bearing and ball bearing.
3. Applicable to pipes turning.
4. The tailstock pressure of lathe adjusts to six to ten kilograms (for reference)

單位/Unit:mm

ORDER NO.	MORSE TAPER MT/MK	A	B	C	D	D1	L	Co精度 Accuracy	Max R.P.M	Load weight	θ	G.W. weight kgs	包裝尺寸 L x W x H
08102050	BC50-MT.2	42	23	69	52	12	134	0.005	4000R.P.M	RPM100=200kg	60°	0.72 kgs	205x60x60
08102063	BC63-MT.2	46	17	69	63	12	132	0.005	4000R.P.M	RPM100=200kg	60°	0.94 kgs	195x86x86
08103050	BC50-MT.3	42	23	86	52	12	151	0.005	4000R.P.M	RPM100=200kg	60°	0.84 kgs	205x60x60
08103063	BC63-MT.3	46	17	86	63	12	149	0.005	4000R.P.M	RPM100=200kg	60°	1.08 kgs	195x86x86
08103078	BC78-MT.3	52	18	86	78	15	156	0.005	3300R.P.M	RPM100=400kg	70°	1.56 kgs	195x86x86
08103106	BC106-MT.3	59	16	86	106	25	161	0.005	3000R.P.M	RPM100=500kg	75°	2.66 kgs	220x120x120
08104050	BC50-MT.4	42	23	108	52	12	173	0.005	4000R.P.M	RPM100=200kg	60°	1.13 kgs	205x60x60
08104063	BC63-MT.4	46	17	108	63	12	171	0.005	4000R.P.M	RPM100=200kg	60°	1.38 kgs	195x86x86
08104078	BC78-MT.4	52	18	108	78	15	178	0.005	3300R.P.M	RPM100=400kg	70°	1.88 kgs	195x86x86
08104106	BC106-MT.4	59	16	108	106	25	183	0.005	3000R.P.M	RPM100=500kg	75°	2.96 kgs	220x120x120
08104128	BC128-MT.4	73	12	108	128	40	193	0.005	2000R.P.M	RPM100=500kg	70°	4.84 kgs	140x140x240
08104156	BC156-MT.4	88	12	108	156	45	208	0.008	1900R.P.M	RPM100=800kg	70°	7.68 kgs	170x170x260
08104206	BC206-MT.4	98	12	108	206	81	218	0.008	1500R.P.M	RPM100=1300kg	70°	15.0 kgs	285x285x360
08104258	BC258-MT.4	107	13	108	258	92	228	0.008	1200R.P.M	RPM100=2000kg	80°	22.0 kgs	285x285x360
08105106	BC106-MT.5	59	16	136	106	25	211	0.005	3000R.P.M	RPM100=500kg	75°	3.86 kgs	220x120x120
08105128	BC128-MT.5	73	12	136	128	40	221	0.005	2000R.P.M	RPM100=650kg	70°	5.70 kgs	140x140x240
08105156	BC156-MT.5	88	12	136	156	45	236	0.008	1900R.P.M	RPM100=800kg	70°	8.54 kgs	170x170x260
08105206	BC206-MT.5	98	12	136	206	81	246	0.008	1500R.P.M	RPM100=1600kg	70°	16.0 kgs	285x285x360
08105258	BC258-MT.5	107	13	136	258	92	256	0.008	1200R.P.M	RPM100=2200kg	80°	25.0 kgs	285x285x360
08105306	BC306-MT.5	107	13	136	306	120	273	0.01	1000R.P.M	RPM100=3000kg	90°	37.0 kgs	340x340x360
08106206	BC206-MT.6	98	12	190	206	81	300	0.008	1500R.P.M	RPM100=2000kg	70°	20.0 kgs	285x285x360
08106258	BC258-MT.6	107	13	190	258	92	310	0.008	1200R.P.M	RPM100=2500kg	80°	29.0 kgs	285x285x360
08106306	BC306-MT.6	107	30	190	306	120	327	0.01	1000R.P.M	RPM100=3000kg	90°	40.0 kgs	340x340x360

自動式傳動頂針

AUTO ADJUSTABLE TRANSMISSION CENTER



NHD 型 TRANSMISSION CENTER



車床、CNC車床適用

1. 此自動式免夾頂針，適用端面不平的加工物。加工時，頂針之5T,6T會自動調整受力點，使加工物件能夠平均受力。
2. 其內部結構為強力優力膠設計，使頂針有較好的耐用性，不易破碎。在維修方面，也較容易更換。
3. 精度：0.008mm

LATHE, CNC LATHE

1. The auto adjustable transmission center is suitable for the asperities of workpieces. The auto adjustable transmission center with 5T and 6T design on end surface is able to adjust the stress point so that the workpieces will be done easily.
2. The inside structure of the center is comprised of PU. It is nearly free of break-down, and is durable and easy to fix.
3. Accuracy: 0.008mm

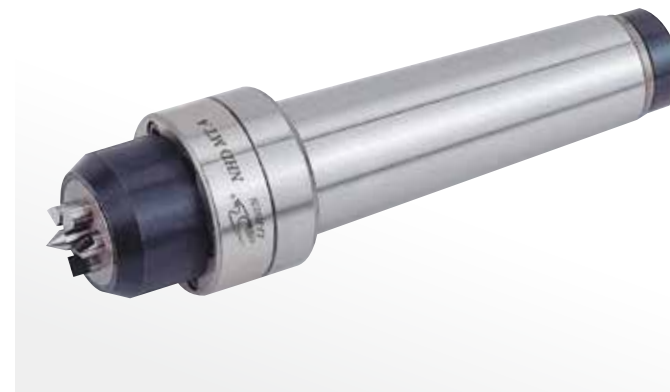

單位/Unit:mm

MORSE TAPER MT / MK	心軸尺寸 Center shaft size	外徑尺寸 Outer Dia.	工作範圍 Working Range	G.W. WEIGHT kgs	包裝尺寸 L x W x H
NHD-31 MT.4	Ø5	Ø16	1 2 Ø~2 0 Ø	1.76 kgs	200 x 90 x 80
NHD-32 MT.4	Ø9	Ø25	1 8 Ø~3 5 Ø	2.30 kgs	200 x 90 x 80
NHD-33 MT.4 / MT.5	Ø14	Ø39	3 0 Ø~5 5 Ø	2.94 / 3.16 kgs	250 x 110 x 100
NHD-34-MT.4 / MT.5	Ø18	Ø53	4 0 Ø~7 0 Ø	4.10 / 4.20 kgs	250 x 110 x 100

零配件 PARTS & ACCESSORIES

www.lihsun.com

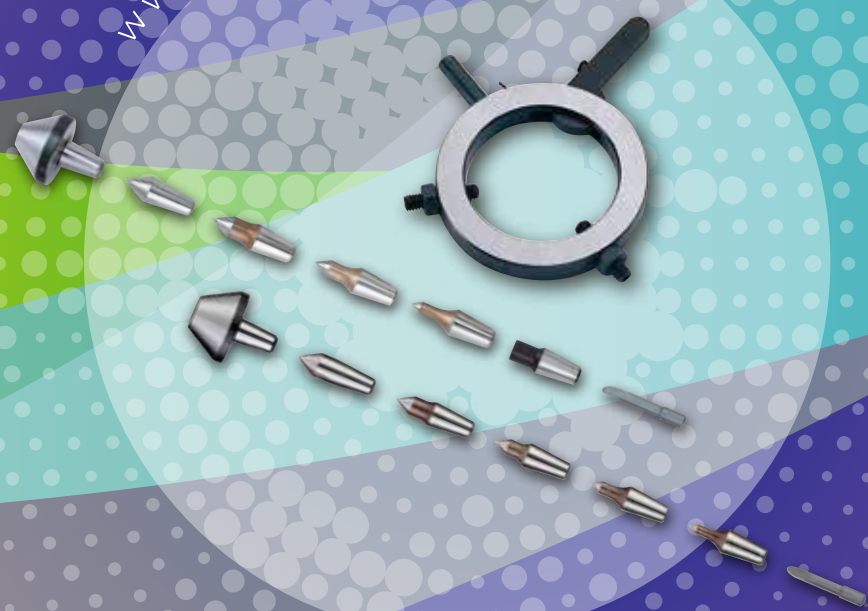

頂針零件 LIVE CENTER(PARTS)



NCS-MT3 MT.4 NKS-MT.2.MT.3.MT.4

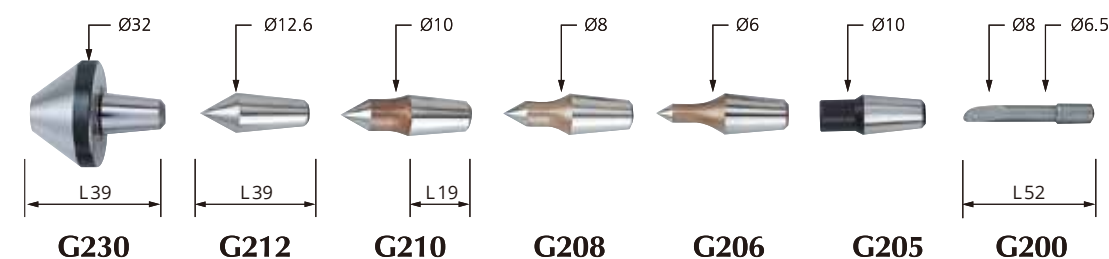

ORDER NO.	SPECIFICATION
08300230	G230
08300212	G212
08300210	G210
08300208	G208
08300206	G206
08300205	G205
08300200	G200

NCS-MT4P MT.5P NCD/NCFP-MT.4 MT.5

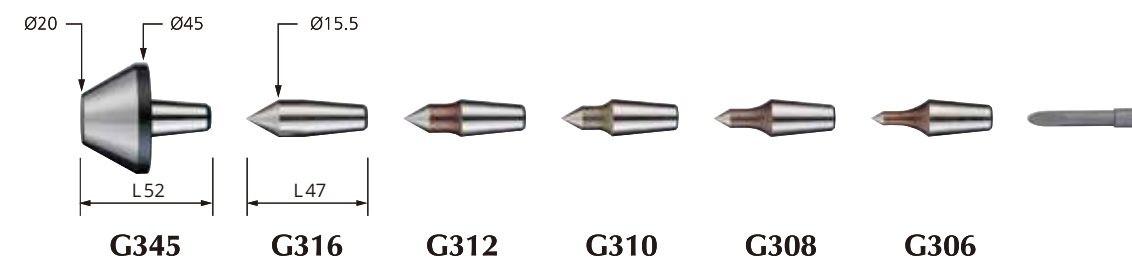

ORDER NO.	SPECIFICATION
08300345	G345
08300316	G316
08300312	G312
08300310	G310
08300308	G308
08300306	G306



DC

型 DRIVING CENTER

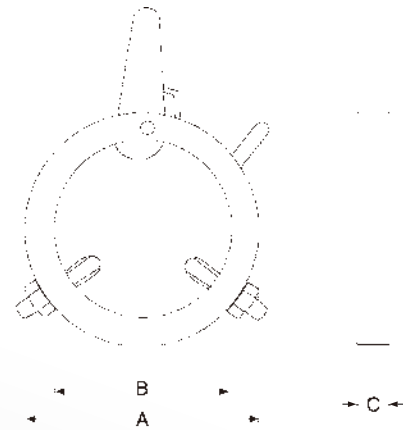

1. 適合於圓筒磨床
2. 操作輕易簡便

1. Suitable for grinding shafts.
2. Easy setup.

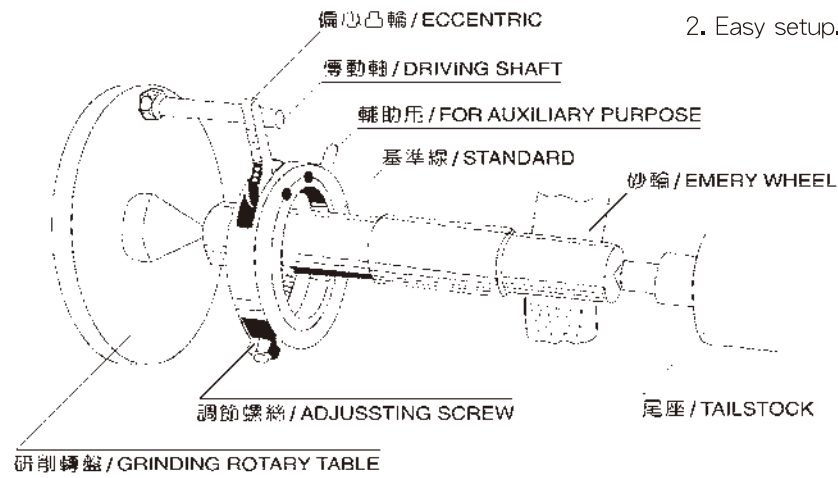

單位/Unit:mm

ORDER NO.	SPEC.	使用範圍/Range	A	B	C	G.W. WEIGHT kgs
08200013	DC-13	6 \varnothing -14 \varnothing	36	18	9	0.06 kgs
08200022	DC-22	13 \varnothing -24 \varnothing	48	28	9	0.08 kgs
08200030	DC-30	20 \varnothing -33 \varnothing	58	38	11	0.12 kgs
08200040	DC-40	31 \varnothing -42 \varnothing	68	48	11	0.14 kgs
08200050	DC-50	35 \varnothing -50 \varnothing	78	58	11	0.16 kgs
08200060	DC-60	40 \varnothing -62 \varnothing	89	68	11	0.18 kgs
08200080	DC-80	60 \varnothing -80 \varnothing	119	88	13	0.46 kgs
08200100	DC-100	80 \varnothing -100 \varnothing	140	109	13	0.54 kgs

客製化頂針 CUSTOMIZED CENTERS

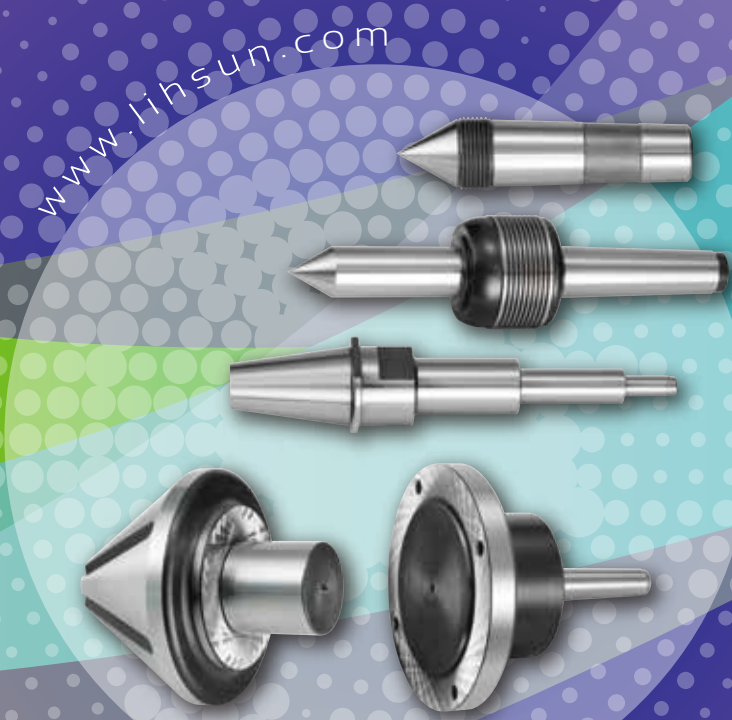

www.lihsun.com



尋邊器 / Z軸設定器 EDGE FINDER & Z AXIAL PRESET GAUGE

www.lihsun.com



SOE

型 OPTICAL EDGE FINDER (TOUCH POINT SENSOR)

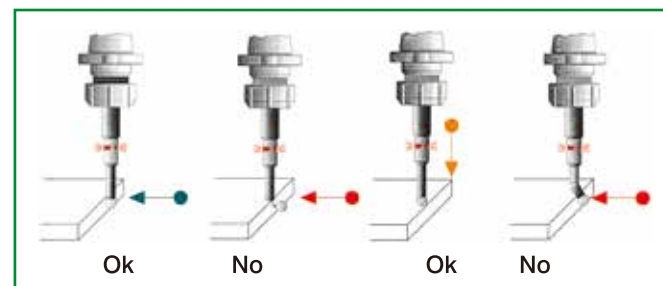

- Not necessary to rotate while measuring.
- Quickly locate work edges.
- Save time to find positions, for milling machine, jig borers, and other machine tools.
- Accuracy 0.005mm

IS A HIGH SENSIBLE POSITION MEASURING

- Uses dry batteries to light the red lamp.
- The scope of application includes edge surface, inside and outside diameters and high efficiency.
- There is a safety spring puller which puts the ball precisely back to the positing when ball breaks away from ball seat.

Battery type:
Um5#, 23A x 12V x 1pcs

- 特點：
- 1. 不需迴轉測量。
- 2. 精確度0.005m/m。
- 3. 附1枚UM5#, 12V 鹼性乾電池。

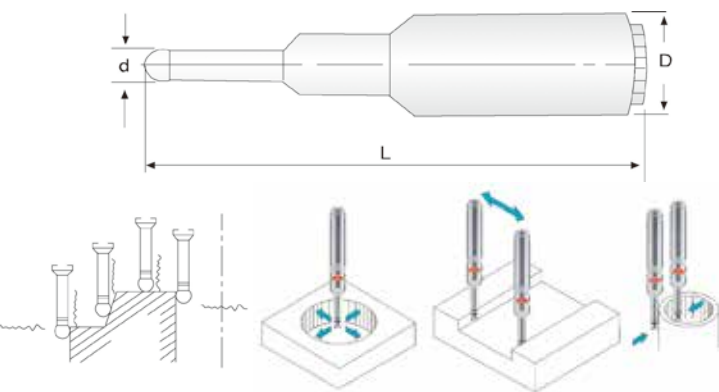

⚠ 請注意 / 光電式尋邊器不適合迴轉使用
Notice to use of optical edge finder, that is not suitably used for rotary.

ORDER NO.	TYPE	柄徑.D	長度.L	測頭.d	G.W. WEIGHT kgs	包裝尺寸 L x W x H
08420120	SOE-20S	20Ø	120	10Ø	0.3	200 x 72 x 45
08420020	SOE-20L	20Ø	158	10Ø	0.36	200 x 72 x 45
08420021	SOE-20LB	20Ø	158	10Ø	0.36	200 x 72 x 45
08420032	SOE-32L	32Ø	158	10Ø	0.64	200 x 72 x 45
08420033	SOE-32LB	32Ø	158	10Ø	0.64	200 x 72 x 45

SME

型 MACHANICAL EDGE FINDER

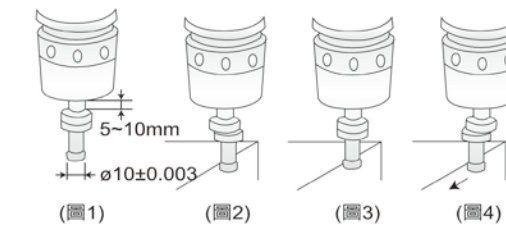
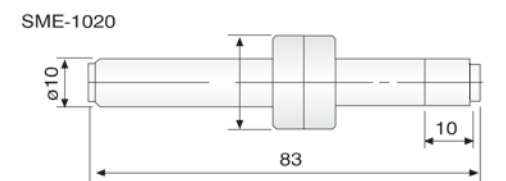
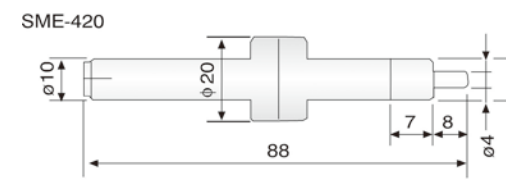
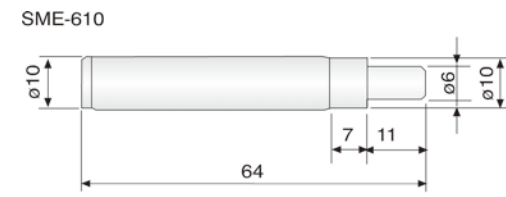

- 注意事項
- 1. 請勿使用其彎曲或勉強拖拉。
- 2. 勿使滑動面沾附異物飛塵。
- 3. 使用時，轉速請勿超過600rpm。
- 4. 不適用在橫式的機器上使用。

Cautions

- Do not use the bend part or to drag or pull with force.
- Never let impurities or foreign things stain on the slide face.
- While using, be sure the speed not over 600rpm.
- Never apply it on machine of horizontal type.

● 特點：

- Ø10mm的直柄可安裝於切削夾頭或鑽夾頭上(參考圖1)
- 請以手指輕壓測定子的側邊，使其偏心0.5mm(參考圖2)
- 使其以400-600rpm的速度轉動。
- 如(圖2)所示使測定子與加工物的端面相接觸，一點一點地碰觸移動，就會變成如(圖3)所示，測定子不再振動，宛如靜止的狀態接著，以更細微的進給來碰觸移動的話，測定子就會如(圖4)所示，開始朝一定的方向滑動。這個滑動起點就是所要尋求的基準位置。
- 加工物本身的端面位置，就是加上測定子半徑5mm的座標位置
- 精度：0.005 mm

FEATURES

- Ø10mm straight shank can be installed directly on milling chuck or drilling chuck. (refer to Fig. 1).
- Press slightly on edge of sensor unit with hands to keep eccentricity at 0.5mm (refer to Fig. 2).
- Rotate with speed of 400-600 rpm.
- Make sensor unit contact to the end face of workpiece shown as Fig. 2. Then, contact and move gradually, it is going to turn into Fig. 3 and sensor unit keeps still. Furthermore, if fine feed is started, then sensor unit will move according to a specific direction. The start point of this movement is the basis position to look for.
- The position of end face of the workpiece is the coordinate position of sensor unit plus radius 5mm.
- Accuracy: 0.005 mm

Steel:Cr-Mo, Alloy Steel (鉻鉬鋼) HRC:58° 單位/Unit:mm

ORDER NO.	TYPE	G.W. weight kgs	包裝尺寸 L x W x H
08400610	SME-610	0.04	95 x 26 x 26
08400420	SME-420	0.07	95 x 26 x 26
08401020	SME-1020	0.07	95 x 26 x 26

Material by Stainless Steel(不鏽鋼) HRC:60° 單位/Unit:mm

ORDER NO.	TYPE	G.W. weight kgs	包裝尺寸 L x W x H
08410420	SME-420ST	0.07	95 x 26 x 26
08411020	SME-1020ST	0.07	95 x 26 x 26

TN型：具有不倒磁之特性塗層處理，硬度HV 2500°
TN Type: Coated surface with nonmagnetic characteristic, the hardness is HV 2500°

ORDER NO.	TYPE	G.W. weight kgs	包裝尺寸 L x W x H
08401100	TN-10	0.08	120 x 45 x 25
08401410	TN-410	0.08	120 x 45 x 25

MEP

型 CERAMIC EDGE FINDER

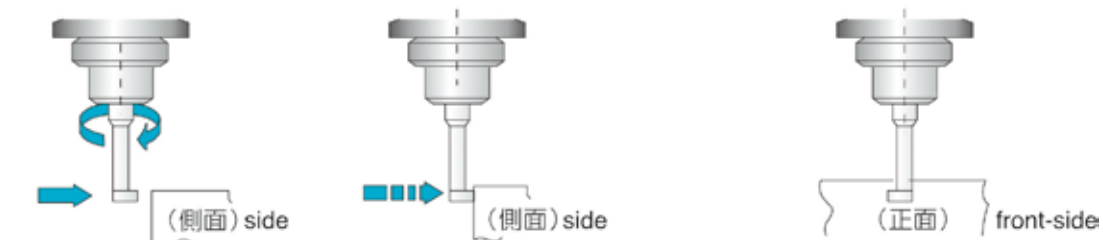
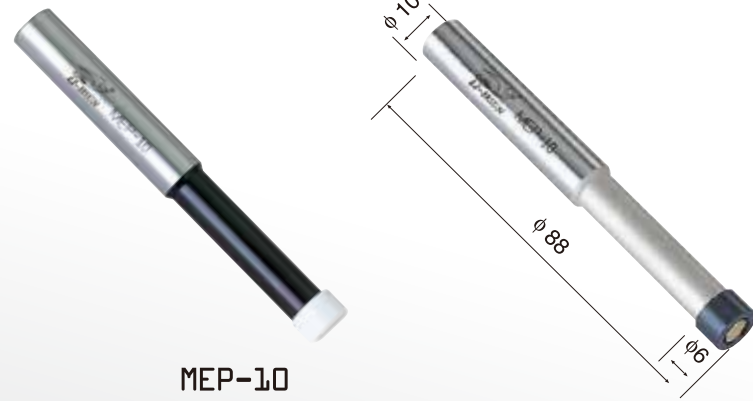

(1) 先把巡邊器回轉後，慢慢靠近測定物。
Turn the Edge Sensor facing to workpiece, then approach to workpiece slowly.

(2) 測定端子的振動到停下來時徐徐移動出去。
Once the sensor touches the workpiece, the sensor block moves backwards.

(3) 再細微的傳出時，急速的偏心的時點，就是測定值。移送測定端子(10m/m)的半徑5m/m時主軸與加工物之端面就一致。
Workpiece position can be calculated by measuring the backward distance of the sensor block. Assuming the moving distance is 10 mm., the spindle center line is in 5 mm position. Move the sensor out of workpiece along with the workpiece edge.

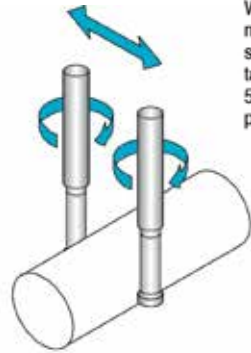
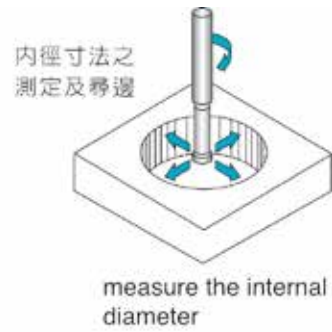

※MEP 型：具有不導磁之特性，前端使用全陶瓷之材質
※精度：0.005mm

※MEP TYPE: The mep type is nonmagnetic, and the front tip wholly made of ceramic.

※Accuracy: 0.005mm

Ceramic[陶瓷] HV:1350°		單位/Unit:mm		
ORDER NO.	TYPE	G.W. weight kgs	包裝尺寸 L x W x H	
08420010	MEP-10	0.06kgs	120 x 45 x 25	
ORDER NO.	TYPE	外徑 Shank Dia.	全長 Length	測定子 Probe Dia.

ZOP-50

型 Z AXIAL PRESET GAUGE (OPTICAL TYPE)



OPTICAL TYPE

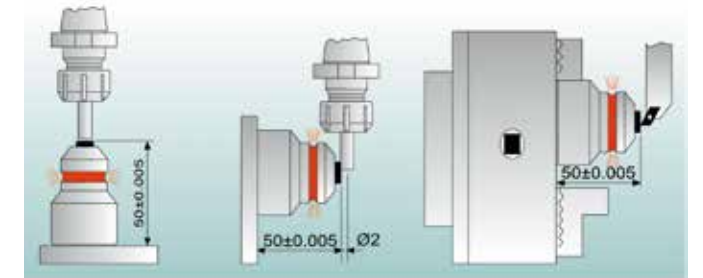

使用方法

1. 探測面下方有微調機構，調整高度請用平行塊規比測。
2. 高精度產品，不適用游標卡尺檢測精度。
3. 快速進刀至燈亮時，請輕微後退至燈熄，再慢速前進至燈亮，以確實掌握精度。
4. 側面探測時，請以刀刃之最高點接觸探測面。

※ 電池：LR44/A76/G13×2枚

ZOP-50

特點：

- 高度50mm容易計算
- 磁性底座設計，可供側面探測。
- 紅燈亮時，四周都可看見，沒有盲點。
- 精度：0.005m/m

FEATURES

- Height: 50mm
- Base built-in magnets for easy setup.
- The red lamp lights-up when touched.
- Height can be micro adjusted and audited by gauge block.
- Can be used vertically or horizontally.
- Weight: 0.3 kgs
- Battery type: LR44 / A76 / G13 x 2 pcs
- Accuracy: within 0.005mm

單位/Unit:mm

ORDER NO.	TYPE	HEIGHT	G.W. WEIGHT kgs	包裝尺寸 L x W x H
08420550	ZOP-50	50±0.005	0.64 kgs	110 x 100 x 80

ZIP-50/50A

型 Z AXIAL PRESET GAUGE (INDICATOR TYPE)

專利在案 (PATENT REGISTERED)



ZIP-50



ZIP-50A

ZOV-50

型



ZOV-50

● 特點：

1. 在電腦銑床/車床上設定刀長用。
2. 設計高度: $50.00 \pm 0.005\text{mm}$ 。
3. 量側面大，操作容易。
4. 彈簧力較小，可避面小銑刀或鑽頭斷裂。
5. 用研磨過的平行板即可簡單設定。
6. ZIP-50A: 平行精度及各方面使用靈敏、精度更好。

FEATURES

1. For setting tool length on machining centers / lathe centers.
2. Setting height: $50.00 \pm 0.005\text{mm}$
3. Large measuring surface and easy to operate.
4. Low spring force to avoid breakage of small end mill and drill.
5. Easy to be calibrated by a ground parallel or gauge block.
6. ZIP-50A: Better parallelism, sensitivity, and precision for use.

單位/Unit:mm

ORDER NO.	TYPE	HEIGHT	G.W. WEIGHT kgs	包裝尺寸 L x W x H
08420551	ZIP-50	$50^{+0.008}_0$	1.08kgs	110 x 100 x 80
08420552	ZOV-50	$50^{+0.008}_0$	1.66kgs	180 x 100 x 70
08420553	ZIP-50A	$50^{+0.005}_0$	1.22kgs	110 x 100 x 80

拉桿螺栓 PULL STUDS



www.lihsun.com

BT

標準型

FOR MAS 403

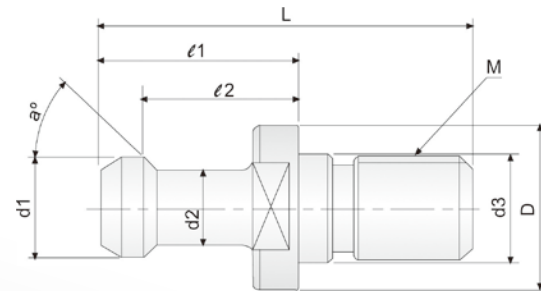

單位/Unit:mm

規格/TYPE	a°	L	l1	l2	D	d1	d2	d3	M	備註/REMARK
BT30x45°	45	43	23	18	16.5	11	7	12.5	M12	
BT30x60°	60	43	23	18	16.5	11	7	12.5	M12	
BT30x90°	90	43	23	18	16.5	11	7	12.5	M12	
BT40x45°	45	60	35	28	23.0	15	10	17.0	M16	
BT40x60°	60	60	35	28	23.0	15	10	17.0	M16	
BT40x90°	90	60	35	28	23.0	15	10	17.0	M16	
BT50x45°	45	90	45	35	38.0	23	17	25.0	M24	
BT50x60°	60	90	45	35	38.0	23	17	25.0	M24	
BT50x90°	90	90	45	35	38.0	23	17	25.0	M24	

BT

水孔型

FOR MAS 403

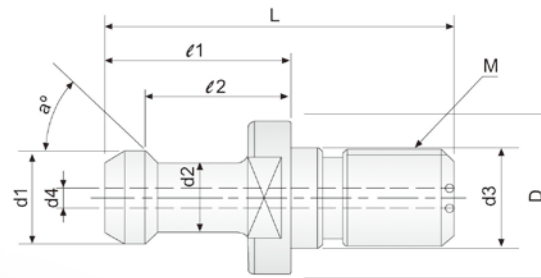

單位/Unit:mm

規格/TYPE	a°	L	l1	l2	D	d1	d2	d3	d4	M	備註/REMARK
BT40x45°W	45	60	35	28	23	15	10	17	7.0	M16	
BT40x60°W	60	60	35	28	23	15	10	17	7.0	M16	
BT40x90°W	90	60	35	28	23	15	10	17	7.0	M16	
BT50x45°W	45	80	45	35	38	23	17	25	11.5	M24	
BT50x60°W	60	80	45	35	38	23	17	25	11.5	M24	
BT50x90°W	90	80	45	35	38	23	17	25	11.5	M24	

DIN A

型

FOR DIN 69872A

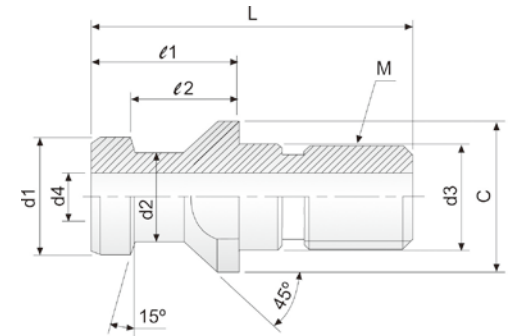

單位/Unit:mm

規格/TYPE	L	l1	l2	D	d1	d2	d3	d4	M	備註/REMARK
DIN30-A	44	24	19	17	13	9	13	-	M12	
DIN40-A	54	26	20	23	19	14	17	7.0	M16	
DIN40-A-L	54	29	23	23	19	14	17	7.0	M16	
DIN50-A	74	34	25	36	28	21	25	11.5	M24	

DIN B

型

FOR DIN 69872B

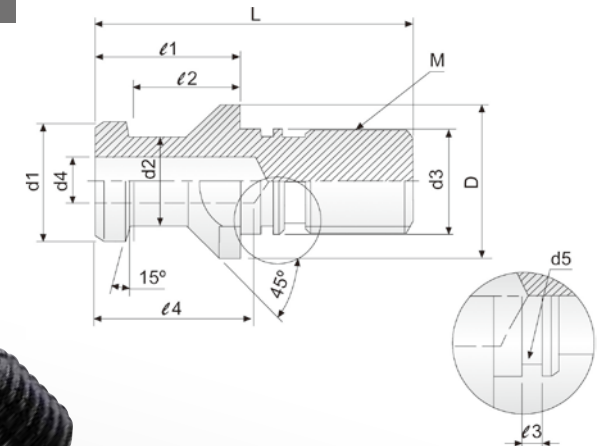

• 不附油封 Without O-ring

單位/Unit:mm

規格/TYPE	L	l1	l2	l3	l4	D	d1	d2	d3	d4	M	備註/REMARK
DIN30-B	44	24	19	1.4	-	17	13	9	13	-	M12	
DIN40-B	54	26	20	1.9	27	23	19	14	17	7.0	M16	
DIN50-B	74	34	25	3.0	37	36	28	21	25	11.5	M24	

夾鑽頭 DRILL CHUCK

www.lihsun.com



INT 型



■一體式主軸更優於傳統設計。

主要特點有：

- 結構緊密。
 - 能防止夾頭脫落。
 - 操作安全。
 - 把傳統結構中柄與夾頭連接產生誤差減少到最小。
- 台灣專利號碼: No.75900 美國專利號碼: No.5275516

■TYPE:INT-C Integrated Type Keyless Drill Chucks

The main-shaft is of integrated type, which is much more superior than the traditional design. The major features are as follows.

1. Extremely rigid construction.
2. The accumulative tolerances can be reduced to a minimum, since the traditional mechanism requiring and arbor to connect the Drill chucks which will generate the accumulative tolerances. The integrated type keyless Drill chuck is designed to solve this problem totally.
3. Prevent the Drill chucks from falling out.
4. Extremely safe in operation.

TAIWAN PAT. NO. 75900 USA PAT. NO. 5275516

精度與扭矩表

Run-out Accuracy & Torque Inspection Table

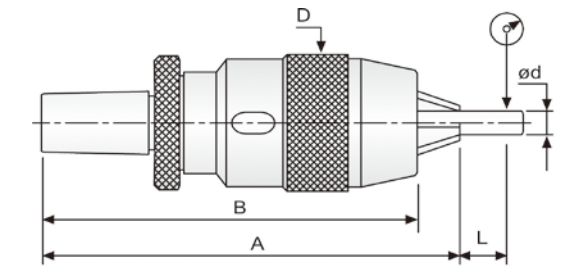

型號/TYPE	d	L	跳動/RUN-OUT	扭矩/TORQUE	
INT-3	3	35	0.05	45	
INT-8	3	35	0.05	160	
	6				
INT-13	5	55	0.05	400	
	10				
INT-16	13	75	0.05	480	
	5				55
	10				
	16	80			

單位/Unit:mm

型號/TYPE	夾持能力/CLAMPING	錐孔或直柄類型	D					
INT-3	0.5~3.175 [1/64"~1/8"]	MT1-C	25.0	127.5	122.5	160	20/0.83	4 / 5
		JC1/2"-C	25.0	107.0	102.0	150	20/0.83	4 / 5
		JC12-C	25.0	107.0	102.0	150	20/0.83	4 / 5
INT-8	0.5~8.0 [1/64"~5/16"]	MT2-C	35.0	157.0	149.0	520	20/0.83	11/12
		JC20-C	35.0	141.0	133.0	500	20/0.83	10/11
		JC3/4"-C						
INT-13	0.5~13.0 [1/64"~1/2"]	R8-C	50.5	207.0	196.0	1500	20/0.83	30/31
		MT2-C	50.5	184.0	172.0	110	20/0.83	22/23
		MT3-C	50.5	201.0	190.0	1250	20/0.83	25/26
		MT4-C	50.5	227.0	216.0	1580	20/0.83	32/33
		JC20-C	50.5	164.0	153.0	1100	20/0.83	22/23
		JC3/4-C						
		JC25-C	50.5	174.0	163.0	1250	20/0.83	25/26
		JC1-C						
		JC32-C						
JC1-1/4-C	50.5	185.0	173.0	1450	20/0.83	29/30		
INT-16	3.0~16.0 [1/8"~5/8"]	R8-C	56.0	211.0	198.0	1850	20/0.83	37/38
		MT3-C	56.0	207.0	194.0	1520	20/0.83	30/31
		MT4-C	56.0	232.0	219.0	1850	20/0.83	37/38
		JC20-C	56.0	165.0	152.0	1450	20/0.83	29/30
		JC3/4-C						
		JC25-C	56.0	175.0	162.0	1500	20/0.83	30/31
		JC1-C						
		JC32-C						
		JC1-1/4-C	56.0	197.0	184.0	1720	20/0.83	35/36

XHSP型鑽夾頭

XHSP TYPE KEYLESS DRILL CHUCK HEADS



XHSP 型



- 針對強扭矩場合的特殊設計和製造
 - 先選的檢測儀器保證了優良的精度要求，夾緊力是其他同類產品的兩倍
 - 配有鎖緊扳手，防止在使用過程中瞬間轉向改變而導致鑽頭脫落
 - 特別適合於CNC中心機和銑床使用
- TYPE: XHSP Keyless Drill Chucks
1. Special design & manufacture against for super heavy torque (Clamping capacity) use.
 2. Owing to inspecting strictly & with excellent RUN-OUT accuracy and quality guaranteed the gripping power is double than the general brands.
 3. Avoid the drill dropped when used in instantaneous change of direction and equipped with spanner for tightening perfect safety.
 4. Especially suitable for CNC machining center & milling machine use.

單位/Unit:mm

型號/TYPE	d	L	跳動/RUN-OUT	扭矩/TORQUE
6XHSP	3	35	0.05	80
	6			
8XHSP	3	35	0.05	160
	8			
10XHSP	3	35	0.05	260
	10			
13XHSP	5	55	0.05	400
	10			
	13			
16XHSP	5	55	0.05	480
	10			
	16			

精度與扭矩表

Run-out Accuracy & Torque Inspection Table

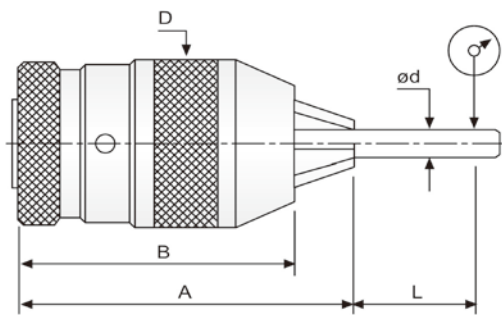

型號/TYPE	夾持能力/CLAMPING	錐孔或直柄類型	D	A	B	重量WT(g)	QTY Pcs/Cu-Ft	淨/毛重NW/GW(Kgs)
6XHSP	0.5~6.5 [1/64"~1/4"]	B12	34.0	69	61	320	8/0.6	26/27
		J1	34.0	69	61	320	8/0.6	26/27
		B10	34.0	69	61	320	8/0.6	26/27
8XHSP	0.5~8.0 [1/64"~5/16"]	J2S	34.0	69	61	320	40/0.6	13/14
		B10	34.0	69	61	320	40/0.6	13/14
		J1	34.0	69	61	320	40/0.6	13/14
10XHSP	0.5~10.0 [1/64"~3/8"]	B12	34.0	69	61	320	40/0.6	13/14
		J33	43.0	92	81	700	40/0.6	28/29
		J2	43.0	92	81	700	40/0.6	28/29
		J2S	43.0	92	81	700	40/0.6	28/29
		B12	43.0	92	81	700	40/0.6	28/29
		B16	43.0	92	81	700	40/0.6	28/29
13XHSP	0.5~13.0 [1/64"~1/2"]	J6	51.5	103	92	1030	30/0.6	31/32
		J2	51.5	103	92	1035	30/0.6	31/32
		J33	51.5	103	92	1035	30/0.6	31/32
		B16	51.5	103	92	1030	30/0.6	31/32
16XHSP	3.0~16.0 [1/8"~5/8"]	J6	58.0	108	95	1450	24/0.6	35/36
		J33	58.0	108	95	1450	24/0.6	35/36
		B16	58.0	108	95	1450	24/0.6	35/36
		B18	58.0	108	95	1450	24/0.6	35/36
		J3	58.0	108	95	1450	24/0.6	35/36
扳手/KEY	8XHSP							
扳手/KEY	10XHSP							
扳手/KEY	13XHSP							
扳手/KEY	16XHSP							

XH型鑽夾頭

XH TYPE KEYLESS DRILL CHUCK HEADS



XH 型



- 適用於銑床、鑽床及重型鑽加工。
- 高精度超強鑽夾頭。
- 剛性好，扭距大。

- Suitable for milling & drilling machine and heavy duty drilling use.
- High precision super drill chucks.
- Good rigidity allows high torque.

精度與扭矩表

Run-out Accuracy & Torque Inspection Table

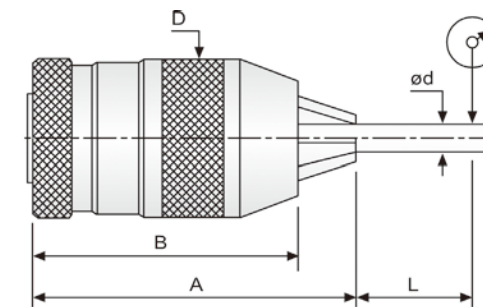

單位/Unit:mm

型號/TYPE	d	L	跳動/RUN-OUT	扭矩/TORQUE
6XHSP	3	35	0.05	80
	6			
8XHSP	3	35	0.05	160
	8			
10XHSP	3	35	0.05	260
	10			
13XHSP	5	55	0.05	400
	10			
	13			
16XHSP	5	55	0.05	480
	10			
	16			

型號/TYPE	夾持能力/CLAMPING	錐孔或直柄類型	D	A	B	重量WT(g)	QTY Pcs/Cu-Ft	淨/毛重NW/GW(Kgs)
6XH	0.5~6.5 [1/64"~1/4"]	B12	34.0	69	61	320	8/0.6	26/27
		J1	34.0	69	61	320	8/0.6	26/27
		B10	34.0	69	61	320	8/0.6	26/27
8XH	0.5~8.0 [1/64"~5/16"]	J1	34.0	69	61	340	40/0.6	14/15
		J2S	34.0	69	61	340	40/0.6	14/15
		B10	34.0	69	61	340	40/0.6	14/15
		B12	34.0	69	61	340	40/0.6	14/15
		J2S	43.0	92	81	700	40/0.6	28/29
10XH	0.5~10.0 [1/64"~3/8"]	J2	43.0	92	81	700	40/0.6	28/29
		J33	43.0	92	81	700	40/0.6	28/29
		B12	43.0	92	81	700	40/0.6	28/29
		B16	43.0	92	81	700	40/0.6	28/29
		J2	51.5	103	92	1030	30/0.6	31/32
13XH	0.5~13.0 [1/64"~1/2"]	J6	51.5	103	92	1030	30/0.6	31/32
		J33	51.5	103	92	1035	30/0.6	31/32
		B16	51.5	103	92	1030	30/0.6	31/32
		J6	58.0	108	95	1370	24/0.6	33/34
16XH	3.0~16.0 [1/8"~5/8"]	B16	58.0	108	95	1370	24/0.6	33/34
		B18	58.0	108	95	1365	24/0.6	33/34
		J3	58.0	108	95	1340	24/0.6	33/34
		J33	58.0	108	95	1340	24/0.6	33/34

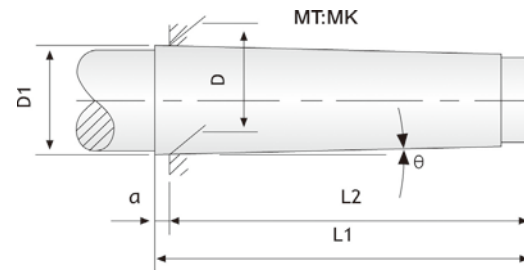

單位/Unit:mm

MORES TAPER MT/MK	a	L1	L2	D	D1	θ
0	3.0	53	50.0	9.045	9.2	1° 29'27"
1	3.5	57	53.5	12.065	12.2	1° 25'43"
2	5.0	69	64.0	17.780	18.0	1° 25'50"
3	5.0	86	81.0	23.825	24.1	1° 26'16"
4	6.5	109	102.5	31.267	31.6	1° 29'15"
5	6.5	136	129.5	44.399	44.7	1° 30'26"
6	8.0	190	182.0	63.348	63.8	1° 29'36"
7	10.0	260	250.0	83.058	83.6	1° 29'22"

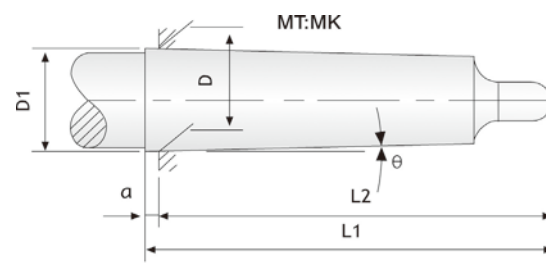

單位/Unit:mm

MORES TAPER MT/MK	a	L1	L2	D	D1	θ
0	3.0	59.5	56.5	9.045	9.2	1° 29'27"
1	3.5	65.5	62.0	12.065	12.2	1° 25'43"
2	5.0	80.0	75.0	17.780	18.0	1° 25'50"
3	5.0	99.0	94.0	23.825	24.1	1° 26'16"
4	6.5	124.0	117.5	31.267	31.6	1° 29'15"
5	6.5	156.0	149.5	44.399	44.7	1° 30'26"
6	8.0	218.0	210.0	63.348	63.8	1° 29'36"
7	10.0	296.0	286.0	83.058	83.6	1° 29'22"

研磨機 RE-SHARPENING

www.lihsun.com



快速銑刀研磨機

FAST END MILL RE-SHARPENING

GH-413 / GH-1225

EASY 簡單

ACCURATE 精確

FAST 快速

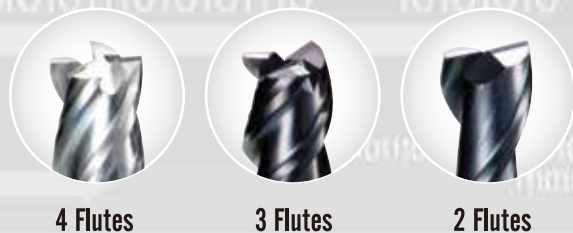

二、四刃專用
for 2 and 4 Flute End Mill

三刃專用
for 3 Flute End Mill



GH-413專利號碼

ZL 200720150355.4
ZL 200720140706.3
Japan第3138310號
M321829號
M325182號
US7,473,163B1號
Nr 202007015258.2

單位/Unit: cm

Patent M321829

型號 Model	研磨範圍 Capacity	馬達 Motor / 轉速 Speed	重量 Weight	包裝尺寸 L X W X H
GH-413	4mm - 13mm	450 w / 6000 rpm	17kgs	310 x 260 x 290
GH-1225	12mm - 25mm	1000 w / 4500rpm	30kgs	360 x 290 x 340

先端角 Axial angles	銑刀端面角 6° Third angle 6°	銑刀後斜角 20° Primary angle 20°	銑刀底溝角 30° Second angle 30°
電源 Power	AC 110 V / AC 220 V 50 / 60 HZ		

標準配件 STANDARD ACCESSORIES ※SDC鎢鋼專用(Carbide) CBN高速鋼專用(High Speed)

電源線	Cable	1 SET
保險絲	Fuse	2 PCS
六角扳手	Hex. key wrench	1 PCS 4mm
鑽石砂輪	Diamond wheel	GH-413 SDC300# (4mm~5mm, carbide end mill) Carbide
		GH-413 SDC300# (6mm~13mm, carbide end mill) Carbide
		GH-1225 CBN150# (12mm~25mm, High Speed end mill) HSS
		GH-1225 SDC150# (12mm~25mm, carbide end mill) Carbide
夾頭	ER chuck	2, 4 flutes chuck *1 set 3 flutes chuck *1 set
筒夾	ER collet	GH-413 4 ~ 13mm(10pcs) / GH-1225 12,16,18,20,22,25mm(6pcs)

特別配件 OPTION ACCESSORIES

鑽石砂輪	Diamond wheel	GH-413 CBN300# (4mm~5mm, High Speed end mill) HSS
		GH-413 CBN270# (6mm~13mm, High Speed end mill) HSS
		GH-413 CBN270# (4mm~13mm, High Speed end mill) 2 flutes HSS
		GH-413 SDC300# (4mm~13mm, carbide end mill) 2 flutes Carbide
		GH-1225 CBN150# (12mm~25mm, High Speed end mill) 2 flutes HSS
		GH-1225 SDC150# (12mm~25mm, carbide end mill) 2 flutes Carbide

GH TYPE 銑刀研磨機

PRECISION END MILL GRINDER



放大圖 Magnified Part

固定檔塊
(硬化處理，避免校正刀座磨損)
Fixed Block
(Harden treatment to protect the alignment base)

定位調整扭
Alignment Knob



定位座
Alignment Base

定位檔塊
Alignment Block

2. 研磨後斜角 20°
NO.2 FOR SCREW RADIAL ANGLE 20°

3. 平面角 6°此橢圓形孔允許夾具軸向移動研磨所有端銑刀面
NO.3 FOR CUTTING ANGLE 6. THIS OVAL SHAPED HOLE ALLOWS HOLDER UNIT TO MOVE ON AXIS TO GRIND ALL SURFACE OF END MILL.

1. 供端銑刀底溝角 30°
NO.1 FOR END MILL FLAT SLOT ANGLE 30°

研磨2.3及4刃端銑刀，精密、效率、易操作，縮短製程時間，研磨直徑

GH413- 4-13mm, GH1225-12-25mm

For End Mill Re-sharpening, 2,3 and 4 Flutes Precision, Efficiency, Easy Operation, Short Processing Time, Grinding Diameter from **GH413- 4-13mm, GH1225-12-25mm.**

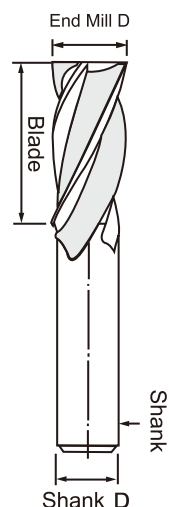

1. 高效率、高品質研磨滑程(滑率)，好的研磨效果。
High Efficiency, High Quality Grinding Slip, Good Grinding Results.
2. 品質保證 0.02mm。
Quality Assurance: 0.02mm.
3. 容易操作，供緊急的方便用具，快速。
Easy Operation, and Fast for Convenience.

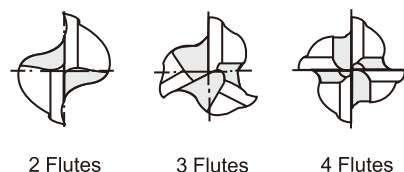
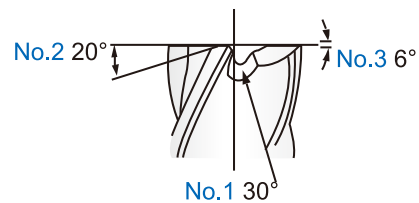

DM TYPE 鑽頭研磨機

FAST DRILL RE-SHARPENING

DM-213



DM-213專利號碼

ZL 200520111362.4
M 279443
Nr 202008009443.7



更換鑽石砂輪步驟

Procedures for changing the grinding wheel

1. 將本機右側旋扭(B1)鬆開，並將側蓋(B2)掀開。
 2. 用4mm六角扳手逆時鐘方向將螺絲(B3)鬆開。
 3. 更換新鑽石砂輪、再將螺絲鎖上即可。
 4. 將側蓋(B2)蓋好，並將旋扭(B1)鎖緊。
1. Loosen the side knob (B1) and open the side cover (B2).
 2. Use a 4mm hexagon wrench to loosen the screw (B3), unscrew it counter clockwise.
 3. Replace with a new diamond grinding wheel and tighten the screw after the wheel is installed.
 4. Be sure to close the side cover (B2) properly and to fasten the side knob (B1).

注意！Attention:

1. 鑽石砂輪螺絲(B3)未鎖緊，側蓋(B2)未蓋好旋扭(B1)未鎖緊前，不可將電源打開，以免發生危險。
2. 本機裝置有斷電系統，砂輪保護蓋掀開時就會自動斷電，以保護操作人員之安全。

Please DO NOT switch on the machine BEFORE

- (1) The diamond wheel screw (B3) is tightly screwed.
 - (2) The side cover (B2) is properly closed.
 - (3) The right knob (B1) is fully fastened.
1. In case of any hazard occurring, please make sure that the above measures are followed strictly.
 2. The machine has an automatic Power-off device to ensure operator's safety. Power supply will be cut-off immediately when the cover is opened.

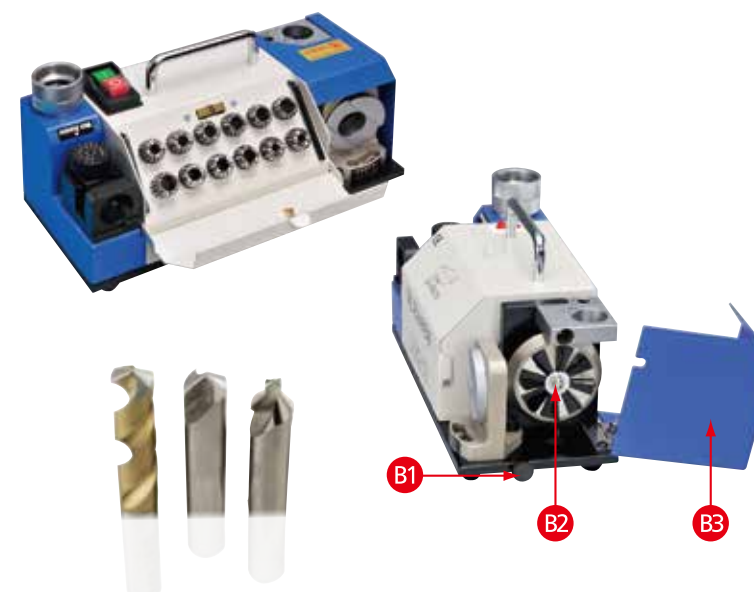

專利項目 Patented Features

1. 雙軸承研磨座。
 2. 鑽頭鎖緊設計裝置有軸承。
 3. 可調節點座。
1. Double-bearing grinding unit (reduces wear).
 2. Drill tightened design with bearing device.
 3. Adjustable trimming angle.

標準附件 Standard Accessories

- DM-213
1. ER筒夾 2.5mm-13mm(12pcs).
 2. CBN鑽石砂輪 #200x1 PCS (高速鋼鑽頭專用).
 3. 六角扳手 4mm, 5mm 各 1 PCS

1. ER Collets, 2.5mm-13mm (12pcs).
2. CBN Dimand wheel #200x1 PCS (High Speed drill).
3. 4mm, 5mm Hexagon (Hex.) wrench x 1 pc each.

特殊附件 Optional Accessories

- DM-213
1. SDC鑽石砂輪 #400 (錫鋼鑽頭專用).
 2. CBN鑽石砂輪 #400 (高速鋼 4mm 以下專用).
 3. ER筒夾 3.5mm~12.5mm(10pcs).
1. SDC #400 Diamond wheel (carbide drill).
 2. CBN #400 Diamond wheel (< 4mm, High Speed drill).
 3. ER Collets, 3.5~12.5mm (10pcs).

單位:mm

型號	Model	DM-213
研磨範圍	Drill Diameter	2 mm - 13 mm
先端角範圍	Point Angle	85°~ 140°
電源	Power Supply	AC110 / AC220 50 / 60HZ
馬達	Motor	90 W
轉速	R.P.M	6000 RPM
重量	Weight	10 kg
包裝尺寸	L X W X H	305 x 172 x 180

DM TYPE 鑽頭研磨機

FAST DRILL RE-SHARPENING

DM-1226



DM-320



更換鑽石砂輪步驟

Procedures for changing the grinding wheel

1. 將本機右側旋鈕(B1)鬆開，並將側蓋(B2)掀開。
 2. 用4mm六角扳手逆時鐘方向將螺絲(B3)鬆開。
 3. 更換新鑽石砂輪、再將螺絲鎖上即可。
 4. 將側蓋(B2)蓋好，並將旋鈕(B1)鎖緊。
1. Loosen the side knob (B1) and open the side cover (B2).
 2. Use a 4mm hexagon wrench to loosen the screw (B3), unscrew it counter clockwise.
 3. Replace with a new diamond grinding wheel and tighten the screw after the wheel is installed.
 4. Be sure to close the side cover (B2) properly and to fasten the side knob (B1).

注意！ Attention:

1. 鑽石砂輪螺絲(B3)未鎖緊，側蓋(B2)未蓋好旋鈕(B1)未鎖緊前，不可將電源打開，以免發生危險。
2. 本機裝置有斷電系統，砂輪保護蓋掀開時就會自動斷電，以保護操作人員之安全。

Please DO NOT switch on the machine BEFORE

- (1) The diamond wheel screw (B3) is tightly screwed.
 - (2) The side cover (B2) is properly closed.
 - (3) The right knob (B1) is fully fastened.
1. In case of any hazard occurring, please make sure that the above measures are followed strictly.
 2. The machine has an automatic power-off device to ensure operator's safety. Power supply will be cut-off immediately when the cover is opened.

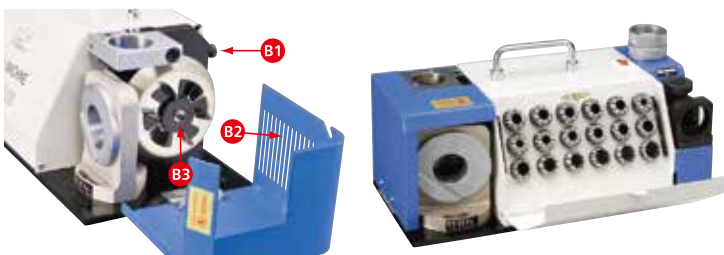

專利項目 Patented Features

1. 雙軸承研磨座。
 2. 鑽頭鎖緊設計裝置有軸承。
 3. 可調靜點座。
1. Double-bearing grinding unit (reduces wear).
 2. Drill tightened design with bearing device.
 3. Adjustable trimming angle.

標準附件 Standard Accessories

- DM-1226
1. ER筒夾 12mm-26mm(15pcs).
 2. CBN鑽石砂輪 #150x1 PCS (高速鋼鑽頭專用)
 3. 六角扳手 4mm,6mm 各 1 PCS
1. ER Collets, 12mm-26mm (15 pcs).
 2. CBN Dimand wheel #150x1 PCS (High Speed drill).
 3. 4mm, 6mm Hexagon (Hex.) wrench x 1 pc each.
- DM-320
1. ER統夾3mm-20mm(18pcs)
 2. CBN鑽石砂輪#200*1PCS(高速鋼鑽頭專用)
 3. 六角扳手4mm,6mm各1PCS
1. ER collet,3mm-20mm(18pcs)
 2. CBN Dimand wheel#200*1 PCS(High Speed drill).
 3. 4mm, 6mm Hexagon (Hex.) wrench x 1 pc each.

特殊附件 Optional Accessories

- DM-1226
1. SDC鑽石砂輪 #200 (錫鋼鑽頭專用).
 2. ER筒夾 8~11mm, 27~30mm (8 pcs).
1. SDC #200 Diamond wheel (carbide drill).
 2. ER Collets, 8~11mm, 27~30mm (8 pcs).
- DM-320
1. SDC鑽石砂輪#200(錫鋼鑽頭專用)
 1. SDC#200 Diamond wheel (carbide drill).

單位:mm

型號 Model		DM-1226	DM-320
研磨範圍 Drill Diameter		12 mm - 26 mm	3 mm - 20 mm
先端角範圍 Point Angle		85°~ 140°	85°~ 140°
電源 Power Supply		AC110 / AC220 50 / 60HZ	AC110 / AC220 50 / 60HZ
馬達 Motor		450 W	450 W
轉速 R.P.M		4000 RPM	4300 RPM
重量 Weight		29 kg	21 kg
包裝尺寸 L X W X H		470 x 260 x 235	480 x 260 x 240

CM-316 簡易型切斷機

CUTTING-OFF

CM-316專利號碼

ZL 200920147543.0
M362076



單位/Unit: cm

型號 Model	切斷範圍 Capacity	馬達 Motor / 轉速 Speed	重量 Weight	包裝尺寸 L X W X H
CM-316	3mm - 16mm	600 w / 6000 rpm	13.5kgs	340 x 210 x 210
電源 Power		AC 110 V / AC 220 V 50 / 60 HZ		

標準配件 STANDARD ACCESSORIES

電源線 Power wires	1 SET
保險絲 Fuse	2 SET
六角扳手 Hex. wrench	4mm / 5mm / 10mm one each
握把 Handle	1 SET
鑽石砂輪 Diamond wheel	SDC80# 1 SET

特別配件 OPTION ACCESSORIES

鑽石砂輪 Diamond wheel	CBN80#
水箱 Water box	-

SG TYPE 短刃鑽頭研磨機

FAST DRILL RE-SHARPENING



SG313專利號碼

ZL 200820153366.2
Japan第3151952號
M356596
Nr 202008013817.5

MD TYPE 3斜度-長刃銑刀型鑽頭研磨機

3 SLANT FAST DRILL RE-SHARPENING



MD213專利號碼

ZL 200900174158.5
M369817

單位/Unit: cm

型號 Model	研磨範圍 Capacity	馬達 Motor / 轉速 Speed	重量 Weight	包裝尺寸 L X W X H
SG-313	3mm - 13mm	200 w / 4200 rpm	13kgs	345 x 175 x 200
先端角 Axial angles	140°	電源 Power	AC 110 V / AC 220 V 50 / 60 HZ	

標準配件 STANDARD ACCESSORIES

電源線 Power wires	1 SET
保險絲 Fuse	1 SET
六角板手 Hex. wrench	4mm / 5mm one each
鑽石砂輪 Diamond wheel	CBN250#
鑽石砂輪 Diamond wheel	CBN400# (5mm down)
ER20夾頭 ER20 collet chuck	1 SET
ER20筒夾 ER20 collet	3~13 mm(11pcs)

特別配件 OPTION ACCESSORIES

ER20筒夾 ER20 collet	3.5, 4.5, 5.5, 6.5, 7.5, 8.5, 9.5, 10.5, 11.5, 12.5 mm
鑽石砂輪 Diamond wheel	SDC250#

單位/Unit: cm

型號 Model	研磨範圍 Capacity	馬達 Motor / 轉速 Speed	重量 Weight	包裝尺寸 L X W X H
MD-213	3mm - 13mm	200 w / 5500 rpm	10 kgs	305 x 172 x 180
MD-1226	12mm - 26mm	450 w / 4000 rpm	28 kgs	470 x 260 x 235
先端角 Axial angles	140°	電源 Power	AC 110 V / AC 220 V 50 / 60 HZ	

標準配件 STANDARD ACCESSORIES

電源線 Power wires	1 SET
保險絲 Fuse	1 SET
六角板手 Hex. wrench	4mm / 5mm one each
鑽石砂輪 Diamond wheel	CBN200#
鑽石砂輪 Diamond wheel	SDC400#
ER20夾頭 ER20 collet chuck	1 SET
ER20筒夾 ER20 collet	2~13 mm(12pcs)
ER40筒夾 ER40 collet	12~26 mm(15pcs)(MD-1226)

特別配件 OPTION ACCESSORIES

ER20筒夾 ER20 collet	3.5, 4.5, 5.5, 6.5, 7.5, 8.5, 9.5, 10.5, 11.5, 12.5 mm
ER40筒夾 ER40 collet	27, 28, 29, 30 mm

EH-832 螺旋角修磨機

Endmill Helix Re-sharpening

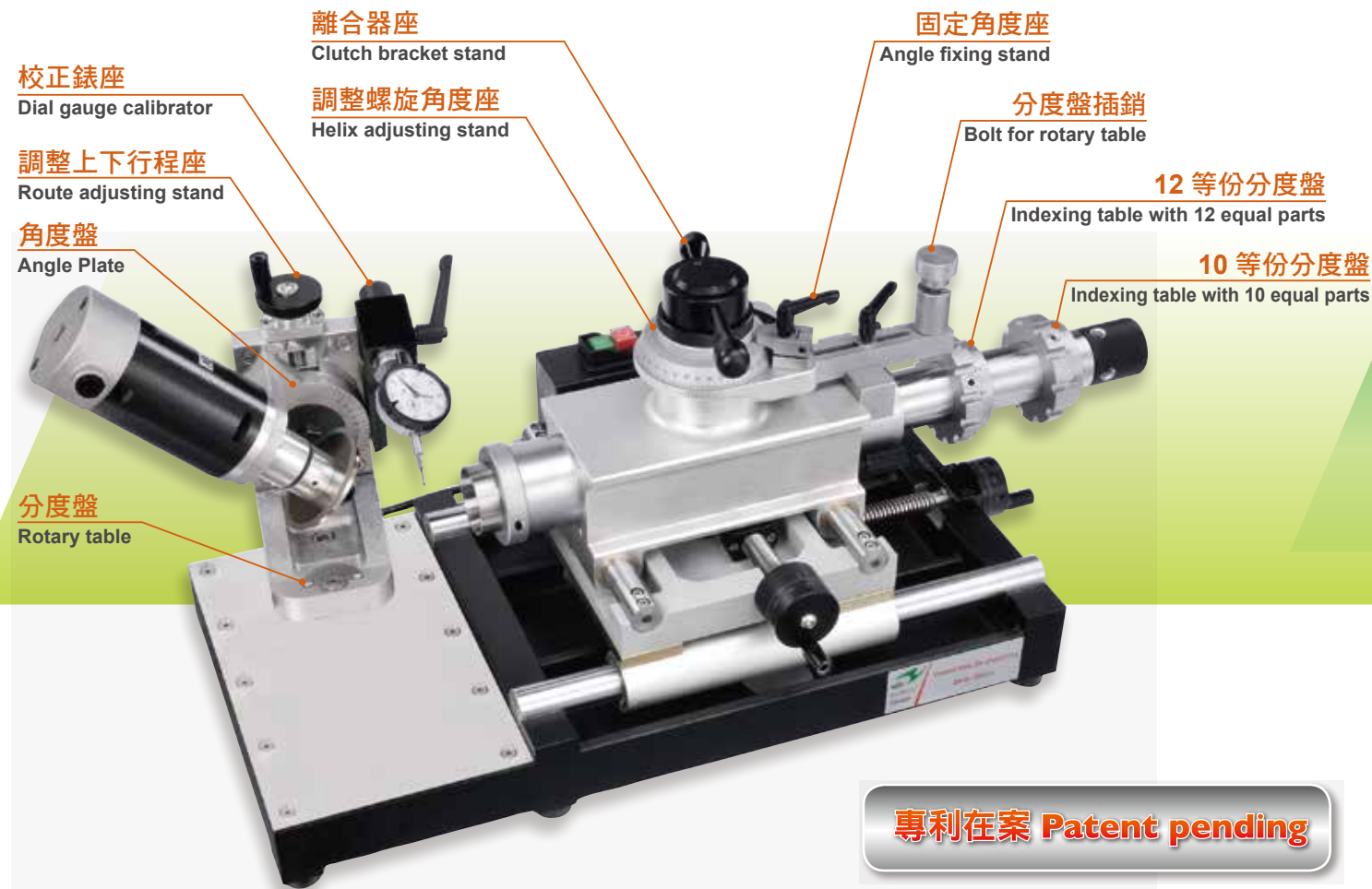

機械規格 SPECIFICATIONS

刀具直徑 Tool diameter	Ø8-Ø32mm
刀具的螺旋長度 Spiral length with workhead spindle	160mm
工作台的前後行程 Longitudinal travel of workhead	150mm
工作台的左右行程 Cross travel of workhead	130mm
砂輪頭的上下行程 vertical movement of wheel head	50mm
砂輪頭的傾斜角度 Tilting angle of wheel head	±90°
心軸的內孔斜度 Workhead spindle	C5
左螺旋及右螺旋的溝槽、前端角、二番角皆能研磨 Spiral flute & axial relief grinding Infinitely variable, left & right hand	
螺旋角 Helix angle	0° - 90°
砂輪孔徑 Grinding wheel Bore	19.06mm
砂輪最大直徑 Grinding wheel diameter	Max. 90mm
砂輪馬達 Grinding motor	0.25KW
砂輪迴轉方向 Grinding wheel direction	正轉 Clockwise
砂輪轉速 Grinding spindle spds	4800 R.P.M.(250w-300w)
機器淨重 Net weight	57KGS
機器外觀尺寸 Dimensions	860×430×500mm
電源 Power supply	AC110/AC220 50/60Hz

本公司隨時進行研究改善的工作，因此本型錄內所規定尺寸驗設計特性，得以變更，不另行通知。
Specifications and design characteristics are subject to change without prior notice.

標準配件 STANDARD ACCESSORIES

斜度研磨裝置 Taper grinding device	
10,12 等份分度盤 One indexing plate 10,12 divisions	
使用工具一套 One set of operating tools	
操作書 One operating instruction manual	
砂輪 Grinding	SDC (1.5 mm , Ø8-12 mm) SDC (2.0 mm , Ø12-32 mm) 鎢鋼專用 Carbide Only
C5 筒夾 Collet	Ø12 , Ø16 , Ø20 , Ø25 , Ø32 mm , 直徑 Diameter Ø50 mm
刀桿 Holder / 筒夾 Collet	C20-SSK10-80L , × 1 pcs (Ø6 , Ø8 , Ø10 mm)

特殊附件 OPTIONS

砂輪 Grinding	CBN(1.5 mm , Ø8-12 mm) CBN(2.0 mm , Ø12-32 mm) HSS 專用 HSS Only
-------------	--

機械特性 MACHINE FEATURES

- EH-832 精密刀具 & 溝槽磨床是一部多功能，而且容易操作的機器，所有側銑刀、面銑刀、殼形銑刀、粗銑刀、端銑刀、螺絲攻、倒角刀、2 刃、3 刃，銑刀螺旋角可研磨 (2,3,4,5,6 刃)……等皆能研磨。
The universal tool & cutter grinder Model EH-832 is versatile in operation without requiring special skills. All milling cutters, endmills , shell endmills , staggered tooth cutters, rough endmills , countersinks (2 flutes, 4 flutes)and the angle of endmill helix can sharpen 2flutes,3flutes,4 flutes, 5flutes, 6 flutes.
- 少量或中批量的高速鋼或碳化鎢刀具、刀具修磨皆很適合在 EH832 上完成。
The Model EH-832 is designed to sharpen HSS and carbide toolings in small and medium quantities.
- 刀具只要一次夾持，即可研磨端面、側面、溝槽。
In one chucking operation, the machine can perform the grinding of the rake angle of the flute, clearance angle on the periphery and the end of the tool.
- 螺旋角度的設定可以很快完成。
A few seconds set up time for helix angle.
- 研磨螺旋刀具時，因為主軸的螺旋運動不會產生間隙，所以特別適合研磨高精度的碳化鎢刀具。
Due to the backlash free operation, spiral toothed, solid carbide or carbide tipped milling cutters can be ground with high accuracy thus far only achieved by CNC grinders.
- 機器的底座和滑板是一體成型，所以穩定性高、堅固耐用。
The heavy duty compound slides and one piece cast-iron base provide extra rigidity and minimize vibration.

CE證書 PATENT CERTIFICATE



各國專利	PATENT	
Country國別	Patent Item 專利名稱	Patent No.專利號碼
China大陸	CH-213鑽頭磨機 CH-213 Drilling Head Grinding Machine	ZL 2005 2 0111362.4
Taiwan台灣	CH-213鑽頭磨機 CH-213 Drilling Head Grinding Machine	新型M279443號
Germany德國	CH-213鑽頭磨機 CH-213 Drilling Head Grinding Machine	Nr 20 2008 099 443.7
China大陸	GH-313磨銑刀機 GH-313 Milling Head Grinding Machine	ZL 2007 2 0150335.4
China大陸	GH-313磨銑刀機 GH-313 Milling Head Grinding Machine	ZL 2007 2 0140706.3
Japan日本	GH-313磨銑刀機 GH-313 Milling Head Grinding Machine	登録第3138310號
Taiwan台灣	GH-313磨銑刀機 GH-313 Milling Head Grinding Machine	新型M321829號
Taiwan台灣	GH-313磨銑刀機 GH-313 Milling Head Grinding Machine	新型M325182號
USD美國	GH-313磨銑刀機 GH-313 Milling Head Grinding Machine	專利號數 US7,473,163B1號
Germany德國	GH-313磨銑刀機 GH-313 Milling Head Grinding Machine	Nr 202007 015 258.2
China大陸	SG鑽頭研磨機 SG Drilling Head Grinding Machine	ZL 2008 2 0153366.2
Japan日本	SG鑽頭研磨機 SG Drilling Head Grinding Machine	登録第3151952號
Taiwan台灣	SG鑽頭研磨機 SG Drilling Head Grinding Machine	新型M356569號
Germany德國	SG鑽頭研磨機 SG Drilling Head Grinding Machine	Nr 20 2008 013 817.5
China大陸	三斜面銑刀型鑽頭研磨機 3-Slant Milling Tool Type Drilling Head Grinding Machine	ZL 2009 0 0174158.5
Taiwan台灣	三斜面銑刀型鑽頭研磨機 3-Slant Milling Tool Type Drilling Head Grinding Machine	新型M369817號
China大陸	圓棒裁斷機 Round Bar Cutting Machine	ZL 2009 20147543.0
Taiwan台灣	圓棒裁斷機 Round Bar Cutting Machine	新型M362076號